

1

2

A

A

B

B

C

C

D

D

技术要求:

1. 该手册印刷颜色均为黑色 :PANTONE BLACK
2. 纸张规格为A5
3. 如果供应商的排版需要加空白页, 请加在封底

						英文用户手册 DW-15F3ME (BS)-G (7635F) (东芝) 巴林		6710029452	
标记	处数	分区	更改文件号	签名	日期	阶段	标记	比例	80G双胶
编制			校对			REV.		1:1	
审核			性能			数量	重量		佛山市顺德区美的 洗涤电器制造有限公司
审定			排版			1			
批准			日期			共 1 张	第 1 张		

1

2

TOSHIBA



DISHWASHER INSTRUCTION MANUAL

Model:

DW-15F3AF(BS)-ZA



Read these instructions carefully before using your DISHWASHER, and keep it carefully.

English

SAFETY INSTRUCTIONS

All instructions described should be carefully read and followed.







- These instructions are precautions to prevent the risks of serious injury or death of the user, and any damages to property.

MARKINGS	
 WARNING	WARNING indicates high possibility of serious injury (*1) or death of the user.
 CAUTION	CAUTION indicates high possibility of serious injury (*2) or property loss (*3).



(*1) Serious injury - injury which requires hospitalization, lengthy treatment, or blindness, hot and cold skin burn, electric shock, broken bones or poisoning.











(*2) Injury - injury, skin burn or electric shock which does not require hospitalization or lengthy treatment.









(*3) Property loss - extended loss of houses, furniture, domestic animals or pets.

SYMBOLS	
 PROHIBITED!	 PROHIBITED! Indicates prohibited actions. Detailed instructions would be indicated on the inside of the circle or around the symbol in figures or in writing.
 IMPORTANT	 IMPORTANT! Indicates mandatory actions. Detailed instructions would be indicated on the inside of the circle or around the symbol in figures or in writing.
 CAUTION	 CAUTION! Recommends to take precautions. Detailed instructions would be indicated on the inside of the triangle or around the symbol in figures or in writing.











Warning











 Away from children	<ul style="list-style-type: none"> ● Do not allow below people to operate the dishwasher The dishwasher cannot be used by persons (including children) with reduced physical, sensory or mental capabilities, or lack of experience and knowledge, unless they have been given supervision or instruction concerning use of the appliance by a person responsible for their safety. ● Take care of children and ensure they will not play with the dishwasher. ● The packing material may be dangerous to children.
 No modification	<ul style="list-style-type: none"> ● Do not dismantle or modify the dishwasher. This may cause fire, electric shock or fault, and cause injuries. If repair is required, please contact with the vendor of the dishwasher.
 Electric shock	<ul style="list-style-type: none"> ● Use suitable power source according to the power indicated on the dishwasher nameplate. It will cause fire or electric shock. The use of improper power source may cause the socket overheated and cause fire.

 Disconnect power plug	<ul style="list-style-type: none"> ● Before cleaning or maintaining the dishwasher, disconnect the power plug first.
 No touch by wet hand	<ul style="list-style-type: none"> ● Do not connect or disconnect the power plug by wet hand. This may cause electric shock or fault and cause injuries.
 Electric shock	<ul style="list-style-type: none"> ● Do not use damaged power lines, power plug or loose power socket. This may cause electric shock or fault, and cause injuries or fires.
 No dis-assembly and repair without permission	<ul style="list-style-type: none"> ● Do not damage power line. Do not damage, cut, process power line or bend, pull, twist or bind power line. Besides, do not yank the metal part of the power line, or put weights on the line or clamp the power line. The power line may be damaged and cause fire or electric shock. If the power line is damaged, the damaged line must be replaced by the manufacturer or its service agent or personnel having similar qualification, so as to prevent dangers.
 No water spraying	<ul style="list-style-type: none"> ● Do not spray water directly onto the parts of the main body of the dishwasher. This may cause accidents of electric shock or short circuit.
 Away from flammable materials	<ul style="list-style-type: none"> ● Do not put flammable materials into the dishwasher. Do not put flammable materials of kerosene, gasoline, volatile oil, diluent, ethyl alcohol etc. as well as dishes having such matters into the dishwasher. It will may cause explosion or fire.
 Wipe off dust	<ul style="list-style-type: none"> ● Wipe off dust or dirt accumulated on the plug of power line. The accumulated dust or dirt may cause fire.
 Prohibit	<ul style="list-style-type: none"> ● Do not touch the inside of the cabinet, steam jets for during operation or 30 minutes after operation. There is a fear of burning.
 Instruction	<ul style="list-style-type: none"> ● Take out the dishes, clean filters, handle it more than 30 minutes after operation. There is a fear of burning.
 Prohibit	<ul style="list-style-type: none"> ● Do not use extension cord. It may cause fire due to heat.
 Instruction	<ul style="list-style-type: none"> ● If there is abnormality such as the spray arm is not moving, smoke or strange smell, immediately unplug the power plug and stop using the dishwasher. Please ask the agent you purchased for inspection/repair. There is a danger of electric shock, fire by electric leakage or short-circuiting.

 Insert plug	<ul style="list-style-type: none"> ● Insert the power plug securely to the base and let the cord go downward. <p>If the cord goes upward or if the plug is incompletely inserted, it may cause fire due to electric leakage or heat generation.</p>
 Prohibit	<ul style="list-style-type: none"> ● Do not operate by putting easily combustible items such as towels and cloth inside the cabinet of the dishwasher. <p>There is a fear of fire.</p>
 Instruction	<ul style="list-style-type: none"> ● Separate from the heat source such as gas stove 15 cm or more. <p>There are fears of fires and deformations.</p>
 Prohibit	<ul style="list-style-type: none"> ● Do not place anything on the main unit. <p>Do not place heavy objects or hot objects on top of the main unit, such as containers of water or hot water, heat appliances, glasses, electric products, cutlery etc.</p> <p>Falling by opening and closing the door may cause injury. Also, spilled water may deteriorate insulation and cause electric leakage and fire.</p>
 Away from flammable materials	<ul style="list-style-type: none"> ● Do not place the dishwasher near fire. ● Do not put the burning candle or cigarette on the dishwasher. It may cause fire.
 Careful installation	<ul style="list-style-type: none"> ● Make sure the dishwasher can be set at a smooth drainage location. <p>The use of dishwasher having poor drainage may cause water to flow back to the dishwasher and cause electric shock or fire.</p>
 Correct grounding	<ul style="list-style-type: none"> ● The dishwasher must be grounded. <p>The current resistance are minimum after grounding, and this can reduce the danger of electric shock when the dishwasher become fault state. The electric wires of this dishwasher have grounding wire and grounding plug.</p> <p>Fault connection of the grounding wire will cause electric shock. If E3 failure occurs, please unplugging the power plug from the outlet, and needs to be repaired by professional electricians or service men.</p>
 No dis-assembly and repair without permission	<ul style="list-style-type: none"> ● Do not change the plug without permission. <p>When the plug does not match the socket, proper power socket shall be installed by professional electricians.</p>

⚠ Caution

 No pulling by force	<ul style="list-style-type: none"> When disconnecting the plug from the socket, do not pull the power line by force. Pull out by grasping the power plug. It may cause electric shock or fault and cause injuries.
 No use	<ul style="list-style-type: none"> Do not use soap, washing powder or other hand sanitizer. Only dishwashing powder suitable for automatic dishwasher. It may cause machine fault.
 No washing	<ul style="list-style-type: none"> Do not wash plastic utensils. For plastic utensils, only those marked with safety for the dishwasher or other similar situations, can be washed by the dishwasher. For the plastic utensils without marks, check details with the utensil manufacturer.
 Application environment	<ul style="list-style-type: none"> Only for indoor use. Such home appliance is for household use, e.g.: <ul style="list-style-type: none"> - Applications in staff kitchen of shop, office and other working environments; - Farmhouse; - Use for customers in hotel, car hotel and other residence environments; - Environments of inns
 No climbing	<ul style="list-style-type: none"> Do not sit or stand on the dish rack or door of the dishwasher. It may cause dangers of injuries due to deformation or damage.
 Pull off power plug	<ul style="list-style-type: none"> When the dishwasher is not used for long time, pull off the power plug from the power socket and close the dishwasher door. Electric shock or short circuit may be caused due to the degradation of insulating material.
 Care about the door	<ul style="list-style-type: none"> The door shall keep close, to prevent stumble. It is very dangerous to open the door during washing, and hot water may cause scald.
 Care for safety	<ul style="list-style-type: none"> When install the items (dishes, utensils etc) into the dishwasher: <ol style="list-style-type: none"> Be careful to put sharp utensil to prevent it from scratch the door sealing strip. Warning: the cutters and other sharp tools must be put in the basket, and the sharp end is put downwards or horizontally.
 Care for cleaning	<ul style="list-style-type: none"> Moisten the soft cloth by mild cleaning solution, then wipe the machine, and wipe it dry by dry cloth.
 Attention	<ul style="list-style-type: none"> After washing, check if the dishwashing powder is empties. Firstly, confirm that there is no error or abnormality notification on the panel before using the dishwasher. When installing the dishwasher, use new water hose. Do not use the current water hose. Maximum inlet water pressure is 1 MPa. Minimum water inlet pressure is 0.04 MPa.

 Loading capacity	<ul style="list-style-type: none"> ● EN50242: Quantity of tableware advised: 173 pcs (Cup x15 + Saucer x15 + Glass x15 + Small serving bowl x1 + Medium serving bowl x1 + Large serving bowl x1 + Dessert dishes x15 + Dinner plate x15 + Soup plate x15 + Oval platter x1 + Soup spoon x15 + Fork x15 + Knife x15 + Teaspoon x15 + Dessert spoon x15 + Serving spoon x2 + Serving fork x1 + Gravy ladle x1)
 Prohibit	<ul style="list-style-type: none"> ● Do not strongly push open door and main body, nor put the downward pressure to the door. Falling may cause injuries.
 Attention to pinching of fingers	<ul style="list-style-type: none"> ● Be careful not to pinch fingers when opening and closing the door. There is a risk of getting hurt while pinching fingers.
 Prohibit	<ul style="list-style-type: none"> ● Do not get close to the exhaust port. Steam or hot air may cause the burns.
 Attention to burn	<ul style="list-style-type: none"> ● While using or after using the dishwasher, pay attention to hot water drained out. High temperature hot water may come out, there is a risk of burns.
 Prohibit	<ul style="list-style-type: none"> ● Prohibit to hit or tap the dishwasher. Electric shock, electric leakage short circuit may cause fire.
 Instruction	<ul style="list-style-type: none"> ● Set the filters correctly. Residues clogs, causing breakdown.
 Prohibit	<ul style="list-style-type: none"> ● Do not put light and small dishes such as plastic containers. If it is dropped by water pressure of the water spray, it may cause malfunction due to clogging the dishwasher.
 Prohibit	<ul style="list-style-type: none"> ● Do not use for purposes other than dishwasher dryer. It may cause a malfunction.
 Instruction	<ul style="list-style-type: none"> ● Make the main unit a solid level surface. Normal operation may not be possible. It may cause water leakage.
 Instruction	<ul style="list-style-type: none"> ● Fix the connection of drainage pipe certainly. It may cause water leakage.

Treatments

- Handle the package of the dishwasher with extreme care.
- All packages are recyclables.
- Plastic parts are marked with abbreviation of international standard;



PE	Polyethylene, e.g., tableted package material
PS	Polystyrene, e.g., packing material
POM	Polyacetal or polyox, e.g., plastic clip
ABS	Acrylonitrile Butadiene Styrene , e.g., control panel
PP	Polypropylene, e.g., inner wall

Warning

- The packing material may be dangerous to children!
- The disposal of package and machine shall be submitted to the recycle center.
- When the machine is not in service, please switch off the power and close the machine door.
- The cardboard package is made by recycled paper and shall be collected for recycling.
- If the generated rubbish cannot be treated properly, they will be harmful to the environment and human health, and they shall be properly disposed to prevent potential threat.



Warning

- For more details of product recycle, please contact relevant departments of local government or the service center for domestic refuse management.
- Treatment: Please do not treat the product as unclassified municipal refuses. Different refuses have to be subject to special treatment separately.

Such warning sign is used to prevent dangers to you and others.
Please follow it strictly.
After reading, please store it properly for use just in case.

Contents

Please carefully read the instruction manual before using the dishwasher, and this is helpful for the use and maintenance of the product.

01	Recognize the dishwasher	
	Dishwasher features	10
	Control panel	11
02	Program Setting	
	Washing program	3
	Start up	14
	Changing the program mid-cycle	14
	Put additional dishes in	15
	End of washing program	15
03	Use the dishwasher	
	Water softener	16
	Adding salt to the softener	17
	Rinse aid and detergent	17
	Adding rinse aid to the dispenser	19
	Adding detergent to the dispenser	20
	Install dishwasher bowl basket	21
	Basket used tips	24
	UV light	27
04	Cleaning and care	
	Filter cleaning	28
	Spray arms cleaning	29
	Care and maintenance	30

05

Installation

Product dimension	31
Power connection	32
Water connection	33
Connection of drain hoses	33

06

Troubleshooting

Before connecting customer service center	35
Error code	37
Specification	38

Recognize the dishwasher

Important:

Before using the dishwasher for the first time, read following instructions to ensure the best results.

Dishwasher features

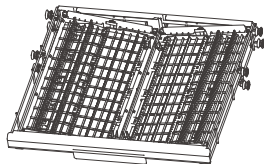
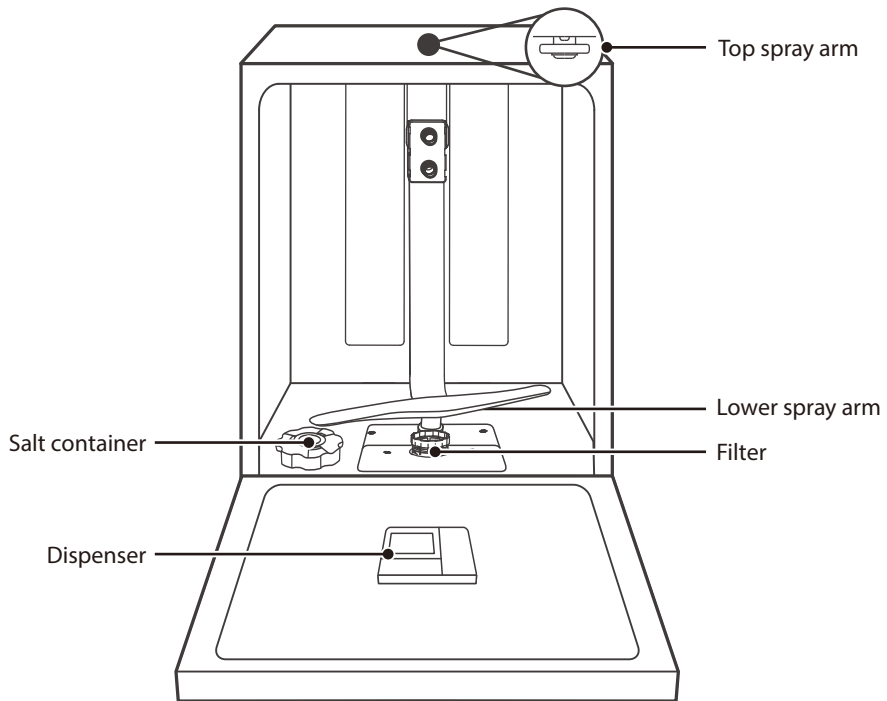

Cutlery rack

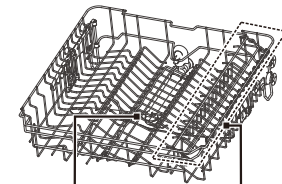

Upper spray arm Cup rack



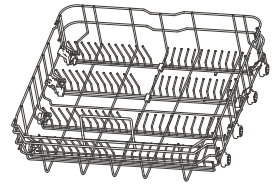





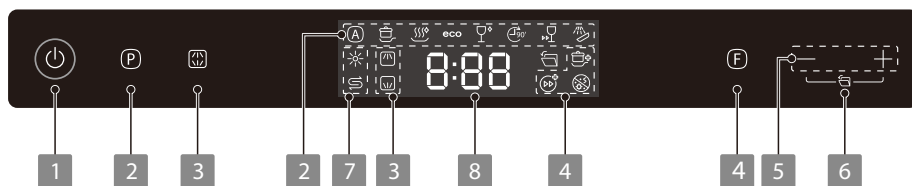

Upper basket







Lower basket

Control panel









1	Power	Power on/off
2	Program	<p>Select the appropriate washing program and the corresponding indicator will light up.</p> <ul style="list-style-type: none"> <li data-bbox="308 603 1014 667">  AUTO Light to heavily soiled daily used items, automatic detection of the amount of soils. <li data-bbox="308 683 1014 746">  INTENSIVE For dishes with oil stains and heavy dirty cooking utensils and dishes. <li data-bbox="308 762 1014 826">  HYGIENE Use to remove bacteria your dishes and glassware. Maintains the water temperature at 70°C. <li data-bbox="308 842 1014 906">  ECO This is standard program. For general dirty dishes and utensils (such as pots, plates, glasses, pans). <li data-bbox="308 922 1014 986">  GLASS For slight dirty dishes and glasses. <li data-bbox="308 1002 1014 1066">  90 MIN For normally soiled loads that need quick wash. <li data-bbox="308 1082 1014 1145">  RAPID For slight dirty dishes, the required cleaning time is relatively short. <li data-bbox="308 1161 1014 1225">  SOAK To rinse dishes that you plan to wash later that day.
3	Alt	<p>Press the button to select either upper basket or lower basket loaded, and the corresponding indicator will light up.</p> <ul style="list-style-type: none"> <li data-bbox="308 1273 1014 1337">  UPPER When you select upper, only the upper rack nozzle is activate. The lower nozzle will not operate. <li data-bbox="308 1353 1014 1417">  LOWER When you select lower, only the lower rack nozzle is activated. The upper nozzle will not operate.

<p>4 Function</p>	<p>Select a function and the corresponding indicator will light up.</p> <p> POWER WASH To wash very dirty, hard to clean dishes. It can only be used with Intensive, Hygiene, Eco, Glass, 90min.</p> <p> TURBO SPEED+ Reduce the program time. It can only be used with Intensive, Hygiene, Eco, Glass, 90min.</p> <p> SANITIZATION Use to sanitize your dishes and glassware. When the icon lights up, the UV light is working. It can be switched on and off by pressing the icon</p>
<p>5 Delay +/-</p>	<p>Press the "+" button to add the delay time or press the "-" button to decrease the delay time, maximum 24 hours delay can be defined.</p>
<p>6 Auto open</p>	<p>After washing, the door will open automatically to achieve better drying effect. The Press and hold the Delay "-" and Delay "+" buttons for 3 seconds to cancel this function. Automatically opens the door when the dishwasher is turned on.</p>
<p>7 Warning Indicator</p>	<p> If the "☀" indicator is lit, it means the dishwasher is low on dishwasher rinse aid and requires a refill.</p> <p> If the "☹" indicator is lit, it means the dishwasher is low on dishwasher salt and requires a refill.</p>
<p>8 Display</p>	<p>To show the remaining time and delay time, error codes etc.</p>

Program Setting

Washing program

Following table shows best cleaning procedures and amount of dishwashing powder required according to the dirty level of the dishes, as well as the

Program	Water Temperature	Dishwashing powder (g)	Time (min)	Power (kWh)	Water (L)	Rinse Aid
 AUTO	65°C	$\frac{5/32.5}{1 \text{ or } 2 \text{ pieces}}$	90-180	0.850-1.550	8.5~18.0	●
 INTENSIVE	65°C	$\frac{5/32.5}{1 \text{ or } 2 \text{ pieces}}$	205	1.500	16.6	●
 HYGIENE	70°C	$\frac{5/32.5}{1 \text{ or } 2 \text{ pieces}}$	200	1.500	13.5	●
eco	50°C	$\frac{5/32.5}{1 \text{ or } 2 \text{ pieces}}$	198	0.776	9.8	●
 GLASS	50°C	$\frac{5/32.5}{1 \text{ or } 2 \text{ pieces}}$	120	0.950	13.5	●
 90MIN	60°C	$\frac{37.5}{1 \text{ piece}}$	90	1.180	12.5	●
 RAPID	45°C	$\frac{20}{1 \text{ piece}}$	30	0.820	11.2	○
 SOAK	/	/	15	/	4.1	○

Attention

The above program data is for reference only. Test conditions are as follows:

- Washing capacity: 173 pcs (Cup x15 + Saucer x15 + Glass x15 + Small serving bowl x1 + Medium serving bowl x1 + Large serving bowl x1 + Dessert dishes x15 + Dinner plate x15 + Soup plate x15 + Oval platter x1 + Soup spoon x15 + Fork x15 + Knife x15 + Teaspoon x15 + Dessert spoon x15 + Serving spoon x 2 + Serving fork x1 + Gravy ladle x1)
- Power consumption at shutdown state and standby state similarly are 0.49w.

Start up

1. The plug shall be firstly plugged into the socket. Power supply shall be of 220-240V AC 50Hz type, with socket of 10 A 220-240V AC.
2. Make sure that the water supply is turned on to full pressure.
3. Open the door, press "ON/OFF" button turn on the dishwasher.
4. Press the button of desired program, the corresponding indicator will light up.
5. Then, close the door, the dishwasher will start its cycle.



Changing the program mid-cycle

A wash cycle can only be changed if it has been running for a short time otherwise, the detergent may have already been released and the dishwasher may have already drained the wash water. If this is the case, the dishwasher needs to be reset and the detergent dispenser must be refilled. To reset the dishwasher, follow the instructions below:

1. Open the door a little to stop the dishwasher, after the spray arm stop working, you can open the door completely.
2. Press the Program button for more than 3 seconds, the dishwasher will enter standby mode.
3. Press the Program button to select the desired program.
4. Then, close the door, the dishwasher will start its cycle.



Put additional dishes in

Additional dishes can be placed in at any time before dishwasher program start. If you want to reload dishes in the process of washing, please follow instructions below:

1. Open the door a little to stop the dishwasher, after the spray arm stop working, you can open the door completely.
2. Put the additional dishes in.
4. Close the door, the dishwasher will start after 10 seconds.

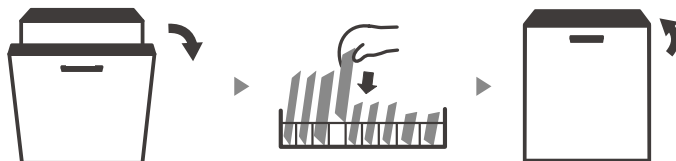

End of washing program

After the program finishes, the machine show "End" after the buzzer beeps for 8 seconds.

- Turn off the machine

Press ON/OFF button to turn off the dishwasher.

- Open the door carefully

Hot dishes are more likely to be damaged. The dishes shall be cool for about 15 minutes and then taken out from the dishwasher.

- Clear the dishwasher

It is normal that the dishwasher still remains wet inside.

Warning

It is extremely emely dangerous to open the door in t he process of washing as this may cause severe burn by hot water.

Use the dishwasher

Water softener

The water softener must be set manually, using the water hardness dial.

The water softener is designed to remove minerals and salts from the water, which would have a detrimental or adverse effect on the operation of the appliance.

The more minerals there are, the harder your water is.

The softener should be adjusted according to the hardness of the water in your area. Your local Water Authority can advise you on the hardness of the water in your area.

Adjusting salt consumption

The dishwasher is designed to allow for adjustment in the amount of salt consumed based on the hardness of the water used. This is intended to optimise and customise the level of salt consumption.

Please follow the steps below for adjustment in salt consumption.

1. Open the door and switch on the appliance.
2. Press the Program button for more than 5 seconds, when the salt indicator flashes means entering the water softener settings.
set model within 60 seconds after the appliance was switched on.
3. Press the Program button to select the proper set according to your local environment, the sets will change in the following sequence:
H1->H2->H3->H4->H5->H6.
4. Without any operation in five seconds, the machine will exit from set mode, the machine is into standby status.

WATER HARDNESS				Water softener level	Salt consumption (gram/cycle)
German °dH	French °fH	British °Clarke	Mmol/l		
0 - 5	0 - 9	0 - 6	0 - 0.94	H1	0
6 - 11	10 - 20	7 - 14	1.0 - 2.0	H2	9
12 - 17	21 - 30	15 - 21	2.1 - 3.0	H3	12
18 - 22	31 - 40	22 - 28	3.1 - 4.0	H4	20
23 - 34	41 - 60	29 - 42	4.1 - 6.0	H5	30
35 - 55	61 - 98	43 - 69	6.1 - 9.8	H6	60

1°dH=1.25 °Clarke=1.78 °fH=0.178mmol/l

The manufactory setting: H3

Contact your local water board for information on the hardness of your water supply.

Adding salt to the softener

⚠ Warning

- **Only use salt specifically designed for dishwashers use!**

Every other type of salt not specifically designed for dishwasher use, especially table salt, will damage the water softener. In case of damages caused by the use of unsuitable salt the manufacturer does not give any warranty nor is liable for any damages caused.

- **Only fill with salt before running a cycle.**

This will prevent any grains of salt or salty water, which may have been spilled, remaining on the bottom of the machine for any period of time, which may cause corrosion.

Please follow the steps below for adding dishwasher salt:

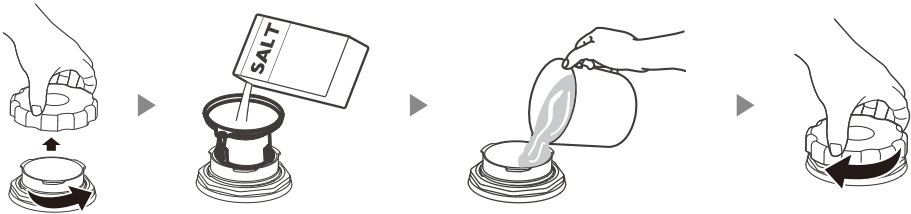

1. Remove the lower basket and unscrew the reservoir cap.
2. Place the end of the funnel (supplied) into the hole and pour in about 1.5kg of dishwasher salt.
3. Fill the salt container to its maximum limit with water, It is normal for a small amount of water to come out of the salt container.
4. After filling the container, screw back the cap tightly.
5. The salt warning light will stop being after the salt container has been filled with salt.
6. Immediately after filling the salt into the salt container, a washing program should be started (We suggest to use a short program). Otherwise the filter system, pump or other important parts of the machine may be damaged by salty water. This is out of warranty.

⚠ Attention

- The salt container must only be refilled when the salt warning light () in the control panel comes on. Depending on how well the salt dissolves, the salt warning light may still be on even though the salt container is filled. If there is no salt warning light in the control panel (for some Models), you can estimate when to fill the salt into the softener by the cycles that the dishwasher has run.
- If salt has spilled, run a soak or quick program to remove it.

Function of the rinse aid and detergent

The rinse aid is released during the final rinse to prevent water from forming droplets on your dishes, which can leave spots and streaks. It also improves drying by allowing water to roll off the dishes. Your dishwasher is designed to use liquid rinse aids.

Warning

Only use branded rinse aid for dishwasher. Never fill the rinse aid dispenser with any other substances (e.g. Dishwasher cleaning agent, liquid detergent). This would damage the appliance.

When to refill the rinse aid

The regularity of the dispenser needing to be refilled depends on how often dishes are washed and the rinse aid setting used.

- The Low Rinse Aid indicator () will appear in the display when more rinse aid is needed.
- Do not overfill the rinse aid dispenser.

Function of detergent

The chemical ingredients that compose the detergent are necessary to remove, crush and dispense all dirt out of the dishwasher. Most of the commercial quality detergents are suitable for this purpose.

Warning

- **Proper Use of Detergent**
Use only detergent specifically made for dishwashers use. Keep your detergent fresh and dry.
Don't put powdered detergent into the dispenser until you are ready to wash dishes.



Dishwasher detergent is corrosive! Keep dishwasher detergent out of the reach of children.

Adding rinse aid to the dispenser

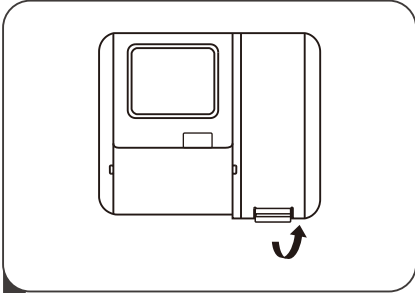

- 1 Remove the rinse reservoir cap by lifting up the handle .

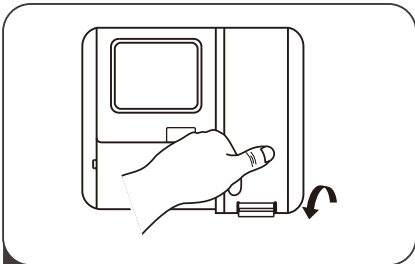

- 3 Close the cap after all.

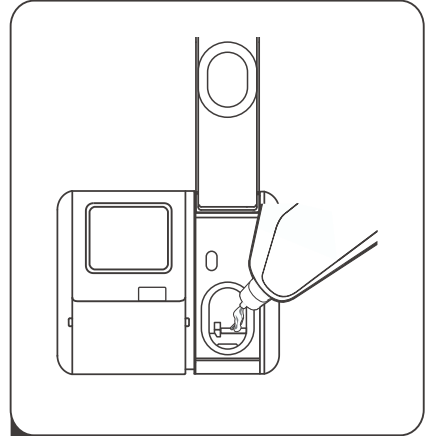

- Pour the rinse aid into the dispenser, being careful not to overfill.

Adjusting the rinse aid reservoir

To achieve a better drying performance with limited rinse aid, the dishwasher is designed to adjust the consumption by user. Follow the below steps.

1. Open the door and switch on the appliance.
2. Within 60 seconds after step 1, press the Program button more than 5 seconds, and then press the Delay "+" button to enter the set model, the rinse aid indication blinks as 1 Hz frequency.
3. Press the Program button to select the proper set according to your using habits , the sets will change in the following sequence: D1->D2->D3->D4->D5->D1. The higher the number, the more rinse aid the dishwasher uses.
4. Without operation in 5 seconds or press the Power button to exit the set model, the set success.

Adding detergent to the dispenser

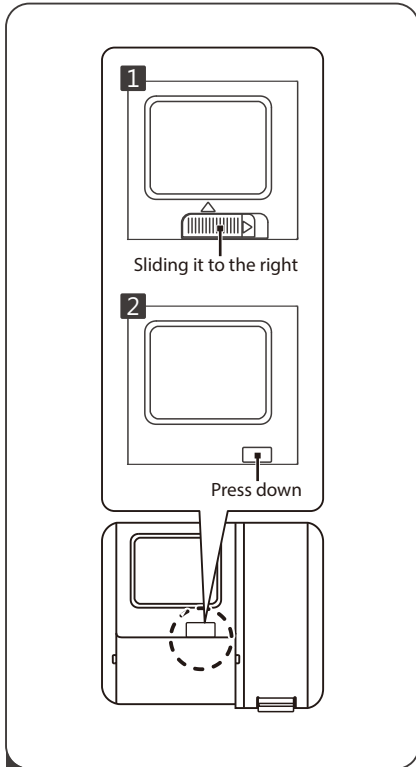

- 1** Please choose an open way according to the actual situation.
1. Open the cap by sliding the release catch.
 2. Open the cap by pressing down the release catch.

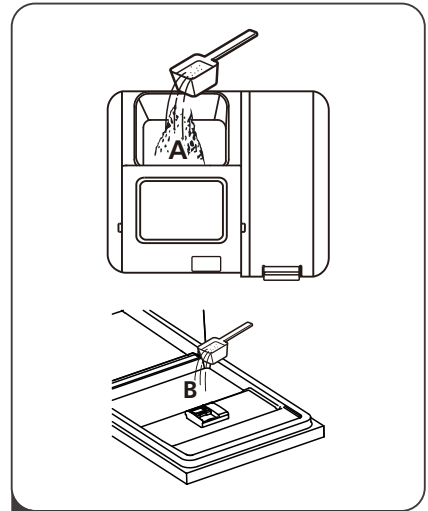

- 2** Add detergent into the larger cavity (A) for the main wash cycle. For better cleaning result, especially if you have very dirt items, pour a small amount of detergent onto the door. The additional detergent will activate during the pre-wash phase.

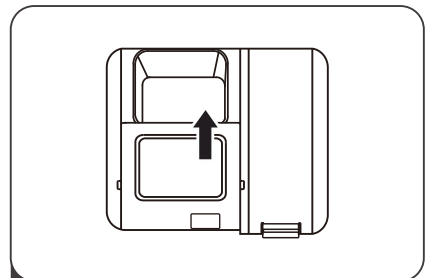

- 3** Close the flap by sliding it to the front and then pressing it down.

Install dishwasher bowl basket

Suggestion

- Purchase dishes suitable for dishwasher.
- Use a suitable mild dishwashing powder. If necessary, consult the manufacturer for more information.
- For special appliances, try to select a washing program that with a lower temperature.
- Do not take out the glass dishes immediately after the program ends to prevent damage.

Use the dishwashing machine rationally

Not for:

- Wooden, ivory, porcelain or pearl shank tool
- Non heat-resistant plastic products
- Stale non heat-resistant cutters with glue adhesive part
- Cohesive knives or dishes
- Tin or copper vessels
- Crystal glass
- Rusty steel products
- Wooden utensils
- Synthetic fiber products

Limited use:

- After several cleanings, some glassware will become dull
- Silver or aluminum products tend to change color during cleaning
- Color of smooth dishes may fade out if often washed

Precautions before and after the bowl basket is placed

(For the best use of dishwasher, follow the instructions below. For different models, the characteristics and appearance of the basket will be different) Clear larger food residues. Soften the residue of burnt food left on the pan. It is not necessary to rinse dishes with water first. Place the dishes in the dishwasher as follows:

- Cups, glasses, pots and so on are placed face down.
- For curved or concave and convex vessels, place them diagonally so that the water flows out.
- All utensils should be placed safely and must not be overturned.
- All utensils should be placed that the arms can rotate freely during washing.

Attention

For small objects, it is easy to fall out from the basket, which should not be placed in the dishwasher.

- The open of hollow tablewares (such as cups, glasses, pots, etc.) should face downward so that water does not easily remain in the container or grooves.
- Dishes and knives should not be placed in other utensils, and they can't overlaid each other.
- Do not place glass close to each other to avoid damage.
- For long knives, placing upright is very dangerous.
- Long or sharp knives (eg. meat cleavers) should be placed horizontally in the basket.
- Do not use the dishwasher overloaded so that you can get better cleaning performance.

Loading the baskets according to EN50242:

Loading the upper basket

Use the upper rack for small or delicate items such as small plates, cups, saucers, glasses, and dishwasher-safe plastic items.

- Place items so that the open end faces down for cleaning and drying.
- Do not stack items on top of each other.

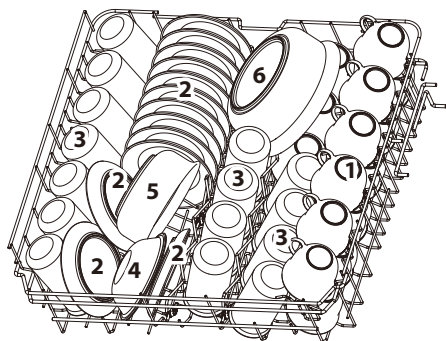

Number	Item
1	Cups
2	Saucers
3	Glasses
4	Small serving bowl
5	Medium serving bowl
6	Large serving bowl

Loading the lower basket

The lower rack is recommended for dinner plates, soup bowls, dishes, pots, pans, lids, and grill trays. Plates should be positioned vertically and facing the center of the rack.

Make sure that large items do not interfere with the rotation of the spray arms, and do not prevent the detergent dispenser from opening.

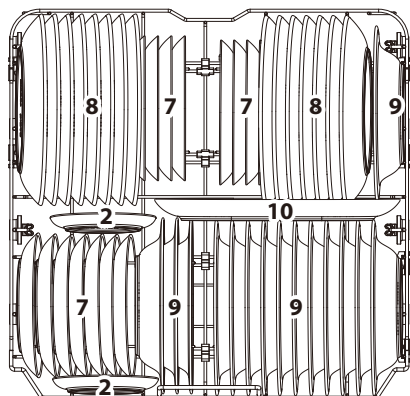

Number	Item
7	Dessert plates
8	Dinner plates
9	Soup plates
10	Oval platter

Loading the cutlery rack

The cutlery rack is best suited for washing flatware and most cooking or serving utensils. The separators on the cutlery racks help keep flatware separated to avoid damage and improve cleaning.

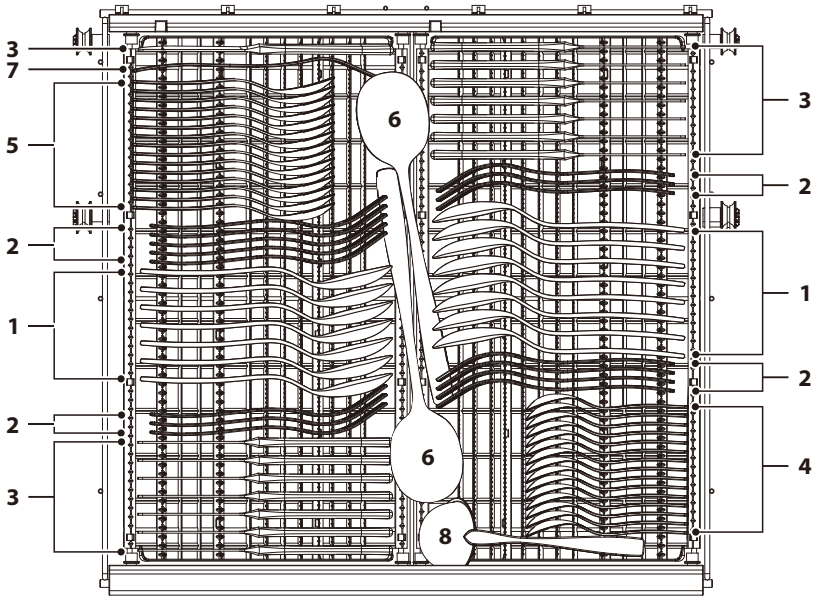

Number	Item	Number	Item
1	Soup spoons	5	Dessert spoons
2	Forks	6	Serving spoons
3	Knives	7	Serving fork
4	Teaspoons	8	Gravy ladle

Basket used tips

Adjusting cutlery rack

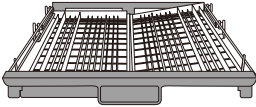
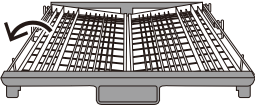

Lift the left basket up, adjust it to lower position, left basket is flat and right basket is sideling.

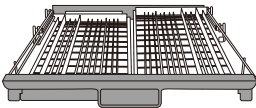
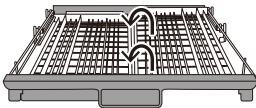

Lift the right basket up, both left and right baskets are flat.

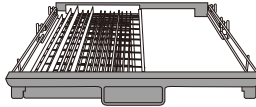
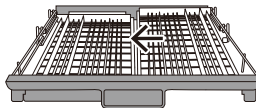

Move the right basket from right to left, two basket are overlapping.

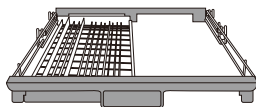
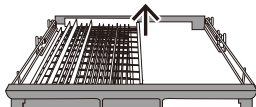

Remove the right basket from the tray, only has the left basket.

Easy removal of cutlery

Using the principle of crank slider mechanism, the cutlery are suspended. Convenient finger goes deep under the knife and fork, and holds several cutlery at a time.

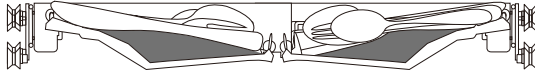

Make the most of space

It can accommodate dishes such as egg beaters, cups, etc., and does not affect the upper basket.

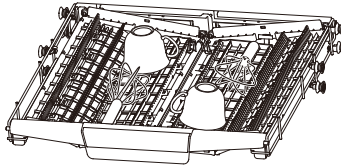

Adjust the height of the rack

Loosen the four buttons on the tray and press down gently.

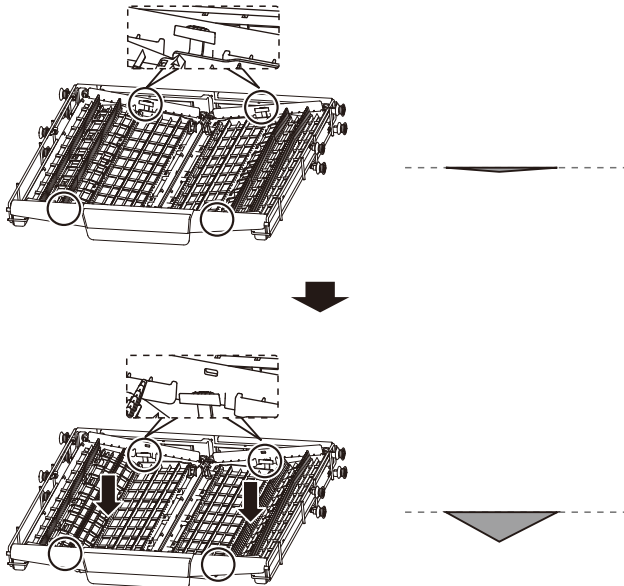

Adjusting the upper basket

The height of the upper basket can be easily adjusted to accommodate taller dishes in either the upper or lower basket. We recommend adjust the height of the upper basket before loading dishes.

To adjust the height of the upper rack, follow these steps:

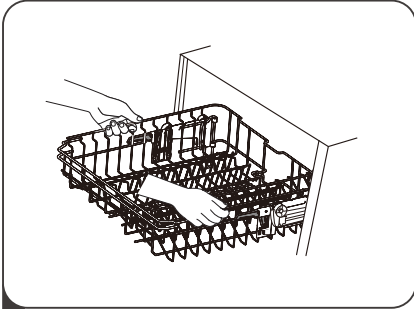

- 1** To raise the upper basket, just lift the upper basket at the center of each side until the basket locks into place in the upper position. It is not necessary to lift the adjuster handle.

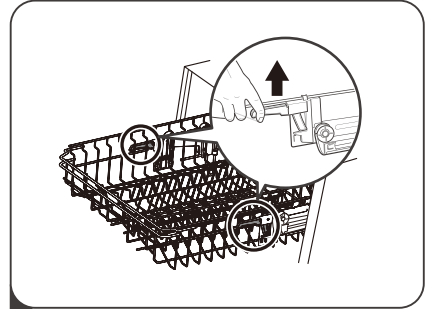

- 2** To lower the upper basket, lift the adjust handles on each side to release the basket and lower it to the lower position.

Folding back the cup shelves

To make room for taller items in the upper basket, raise the cup rack upwards. You can then lean the tall glasses against it. You can also remove it when it is not required for use.

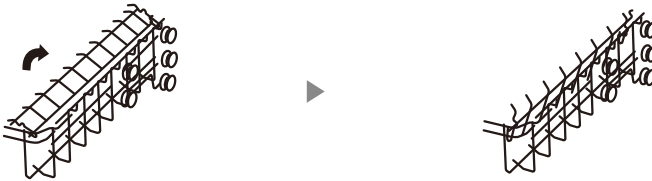

Folding back the rack shelves

The spikes of the lower basket are used for holding plates and a platter. They can be lowered to make more room for large items.

raise upwards

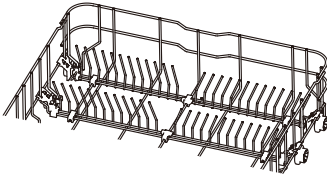

fold backwards

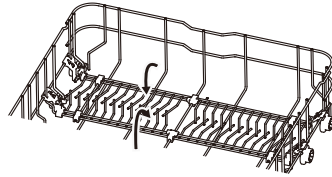

UV light

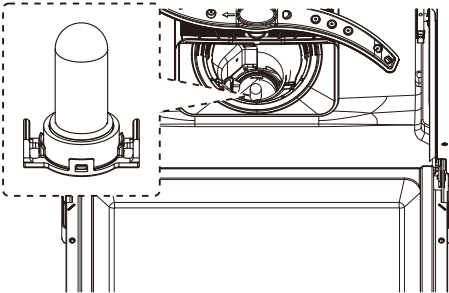

The UV light with antibacterial effect is installed in the sump. When the door is opened, the blue indicator will light up and the UV light closed. When the door is closed, the blue indicator is off, and the UV light will light up at the certain time.

Cleaning and care

Filter cleaning

The filtering system in the base of the wash cabinet retains coarse debris from the washing cycle. The collected coarse debris may cause the filters to clog. Check the condition of the filters regularly and clean them if necessary under running water. Follow the steps below to clean the filters in the wash cabinet.

⚠ Warning

- Do not over tighten the filters. Put the filters back in sequence securely, otherwise coarse debris could get into the system and cause a blockage.
- Never use the dishwasher without filters in place. Improper replacement of the filter may reduce the performance level of the appliance and damage dishes and utensils.

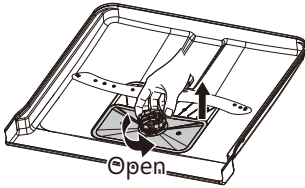

- 1** Hold the coarse filter and rotate it anticlockwise to unlock the filter. Lift the filter upwards and out of the dishwasher.

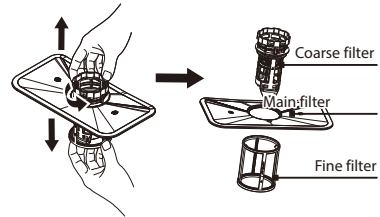

- 2** The fine filter can be pulled off the bottom of the filter assembly. The coarse filter can be detached from the main filter by gently squeezing the tabs at the top and pulling it away.

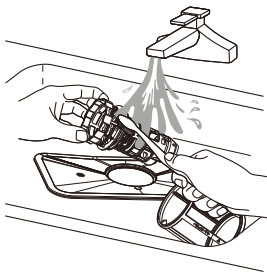

- 3** Larger food remnants can be cleaned by rinsing the filter under running water. For a more thorough clean, use a soft cleaning brush.

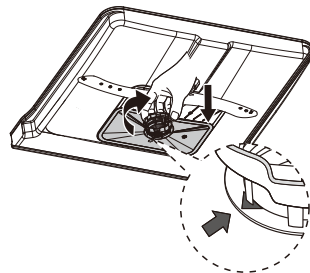

- 4** Reassemble the filters in the reverse order of the disassembly, replace the filter insert, and rotate clockwise to the close arrow.

Spray arms cleaning

It is necessary to clean the spray arms regularly for hard water chemicals will clog the spray arm jets and bearings.

To clean the spray arms, follow the instructions below:

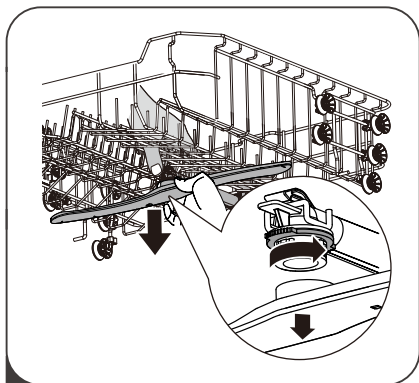

- 1** To remove the upper spray arm, hold the nut in the center still and rotate the spray arm counterclockwise to remove it.

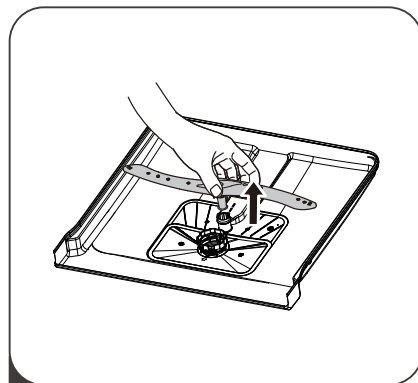

- 2** To remove the lower spray arm, pull out the spray arm upward.

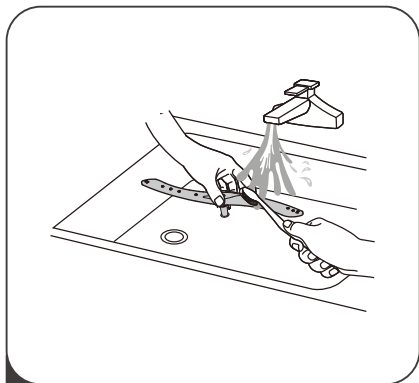

- 3** Wash the arms in soapy and warm water and use a soft brush to clean the jets. Replace them after rinsing them thoroughly.

Care and maintenance

The door and the door seal

Clean the door seals regularly with a soft damp cloth to remove food deposits. When the dishwasher is being loaded, food and drink residues may drip onto the sides of the dishwasher door. These surfaces are outside the wash cabinet and are not accessed by water from the spray arms. Any deposits should be wiped off before the door is closed.

The control panel

Control panel can be wiped with a slightly wet cloth. After cleaning, make sure it is completely dry.
Do not use Sharp tools, Scratch sponge, or Rough detergent anywhere in the machine.

Warning

- Do not use spray detergent to clean the door, as it may damage the door lock and other electrical components.
- Do not use abrasives or rough paper towels, as it may leave scratches or spots on stainless steel surface.

The UV light

UV light does not require extra cleaning. If it breaks accidentally in the process of use, please cut off the power supply to suspend the use and ask someone to clean and replace it.

Installation

Product dimension

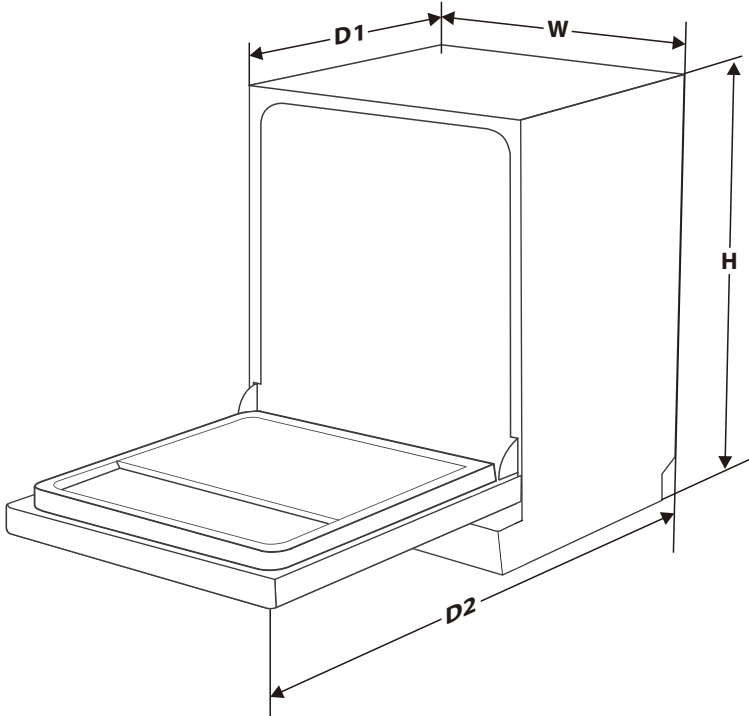

Height (H)	845mm
Width (W)	598mm
Depth (D1)	600mm (with the door closed)
Depth (D2)	1175mm (with the door opened 90°)

Warning



Electric Shock

The machine shall be installed after the power is off. If not, electric shock or death can be caused.

Please make sure the machine is properly grounded before use.

Power connection

Warning

Electric Shock

- Do not use an extension cord or power adapter on this machine.
- In case, do not cut off or remove the grounding connection of power cord.

Power requirements

Please check the label of rated value of power supply system for knowing rated voltage and connect the machine to appropriate power supply. 10A fuse is required and time-delay fuse or circuit breaker is recommended. Only separate circuit is suitable for this machine.

Machine connection

Make sure that supplied voltage and frequency correspond to those on rating plate. Plug can only be connected to a properly grounded socket. If the socket that the machine must be connected to is not suitable for the plug, replace the socket, and do not use a power adapter that may cause overheating and burning.

Water connection

Connect the cold water supply hose to a threaded 3/4(inch) connector and make sure that it is fastened tightly in place.

If the water pipes are new or have not been used for an extended period of time, let the water run to make sure that the water is clear. This precaution is needed to avoid the risk of the water inlet to be blocked and damage the appliance.

Connection of drain hoses

Insert the drain hose into a drain pipe with a minimum diameter of 4 cm, or let it run into the sink, making sure to avoid bending or crimping it. The height of drain pipe must be less than 1000mm. The free end of the hose must not be immersed in water to avoid the back flow of it.

⚠ Please securely fix the drain hose in either position A or position B

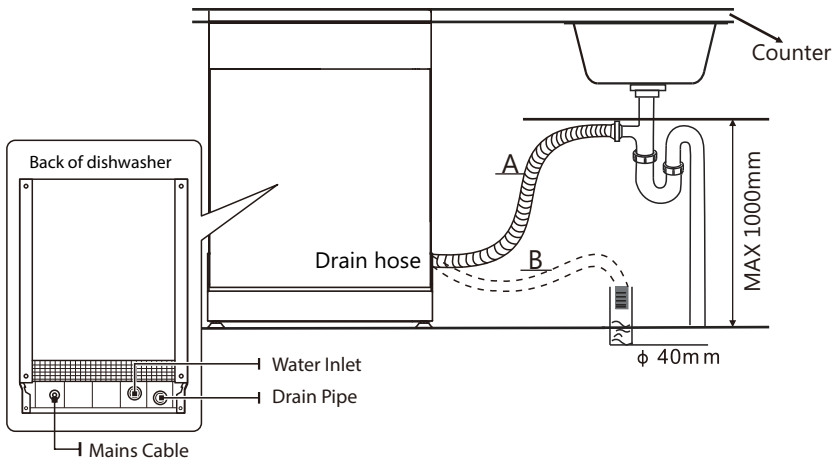

How to drain excess water from hoses

If the sink is 1000 higher from the floor, the excess water in hoses cannot be drained directly into the sink. It will be necessary to drain excess water from hoses into a bowl or suitable container that is held outside and lower than the sink.

Water outlet

Connect the water drain hose. The drain hose must be correctly fitted to avoid water leaks. Ensure that the water drain hose is not kinked or squashed.

Extension hose

If you need a drain hose extension, make sure to use a similar drain hose. It must be no longer than 4 meters; otherwise the cleaning effect of the dishwasher could be reduced.

Syphon connection

The waste connection must be at a height less than 100 cm (maximum) from the bottom of the dish. The water drain hose should be fixed .

Troubleshooting

Before connecting customer service center

Please check the chart below before connecting customer service center

Problem	Possible cause	Solutions
The machine is not working	Fuse burn-out or circuit trip.	Replace fuse or reset circuit breaker Remove any other appliances that share same circuit with the dishwasher.
	Power is not connected.	Make sure that dishwasher is on and the door is firmly closed. Make sure power cord is properly plugged into the socket.
	Door is open.	Close the door.
Insufficient drainage	Drainage pipe has a knot or is blocked.	Check the drainage pipe.
	Filter is blocked.	Check coarse filter.
	Sink drain is blocked.	Check the sink drain to ensure good drainage. If the kitchen sink drain is not working properly, you shall ask a pipe technician for help rather than a dishwasher qualified serviceman.
Foam remains in liner	Improper dishwashing powder is used.	In order to avoid foaming, only dishwashing powder specially designed for dishwasher can be used. In such case, open the door and allow the foam to evaporate. In case of too much foam, start any washing program for cleaning.
	Detergent overflows.	Wipe off spilled cleaner immediately.
Colors on liner	Use dishwashing powder with coloring agent.	Make sure that dishwashing powder used is free of coloring agent.
White film on liner	Hard water minerals.	Use wet sponge with dishwashing powder and wear rubber gloves for interior cleaning. Do not use any detergent other than dishwashing powder as it may generate foam or bubble.
Rust on dishes	Dishes with rust are easily to be corroded.	Avoid washing dishes that are easily to be corroded in dishwasher.
Crush in dishwasher	Dishes in the rack prevents spray arm from rotating.	Suspend the program and reposition the dishes that prevent spray arm from rotating.

Problem	Possible cause	Solutions
Noise from dishwasher	Dishes are loose.	Suspend the program and reposition the dishes.
Beats in water pipe	This may be caused by site installation or cross section	It has no effect on operation of dishwasher. In case of any doubts, please contact qualified pipe technician.
Dishes remain dirty after washing	Dishes are not placed correctly.	Please see "Install dishwasher bowl basket" information for details (Page 22).
	The program is not powerful enough.	Select a more powerful program.
	Dishwashing powder is not enough.	Use more dishwashing powder or replace new detergent.
	Placement of dishes affects the rotation of spray arm.	Reposition the dishes so that spray arm can rotate freely.
	Filter assembly is dirty or not properly installed on the base, which may impede the rotation of spray arm.	Clean or properly install the filter and clean spray arm.
Glassware is not glossy	Add too much dishwashing powder under soft water conditions.	If soft water is used, use less powder and select a shorter washing program to clean the glassware.
White point on dishes or glassware	Hard water produces more scale.	Add dishwashing powder.
Black or grey imprints on dishes	Friction between aluminum utensil and dishes.	Use mild detergent to eliminate these imprints.
Dishwashing powder remains in adding position	Placement of dishes hinders the addition of dishwashing powder.	Place the dishes correctly.
Dishes are not completely dry	Placement is improper.	Please see "Install dishwasher bowl basket" information for details (Page 22).
	Dishes are taken out too early.	Do not take dishes out immediately after the program ends. Slightly open the door let the vapor out and wait until dishes are cool.
	Program is wrong.	When shorter washing procedures are used, washing temperature is lower and cleaning effectiveness is reduced. A longer program shall be selected.
	The dishes have poor drainage ability.	These dishes have poor drainage ability, which are not suitable to be washed in dishwasher.

Error code

When failure occurs, error code will appear to remind you:

Error code	Code name	Possible cause
E1	Long water intake time	Flow-meters, drain valves, or pump failures shall be repaired by qualified serviceman.
E3	Abnormal heating	Heating pipe or thermistor is at abnormal state, which needs to be unplugged the power plug from the outlet , and needs to be repaired by qualified serviceman.
E4	Overflow or water tank problem	The machine occur overflow or something wrong with the floater in the water tank, needs to be repaired by qualified serviceman.
Ed	Abnormal communication	Need to be repaired by qualified serviceman.
EC	BLDC motor failure	Need to be repaired by qualified serviceman

Specification

Model	DW-15F3AF(BS)-ZA
Dimension (mm)	598 (W) x 845 (H) x 600 (D)
Rated voltage	220-240V
Rated frequency	50 Hz
Rated power	1760-2100 W
Water consumption	9.8 L
Power consumption	0.776 kWh
Control mode	Electronic type
Water-proofing grade	IPX1
Washing capacity	173 pcs (Cup x15 + Saucer x15 + Glass x15 + Small serving bowl x1 + Medium serving bowl x1 + Large serving bowl x1 + Dessert dishes x15 + Dinner plate x15 + Soup plate x15 + Oval platter x1 + Soup spoon x15 + Fork x15 + Knife x15 + Teaspoon x15 + Dessert spoon x15 + Serving spoon x 2 + Serving fork x1 + Gravy ladle x1)
Total weight	56.5 kg
Net weight	51 kg