

**TOASTER OVEN
INSTRUCTION MANUAL
TL2-AC25CZA(GR)**

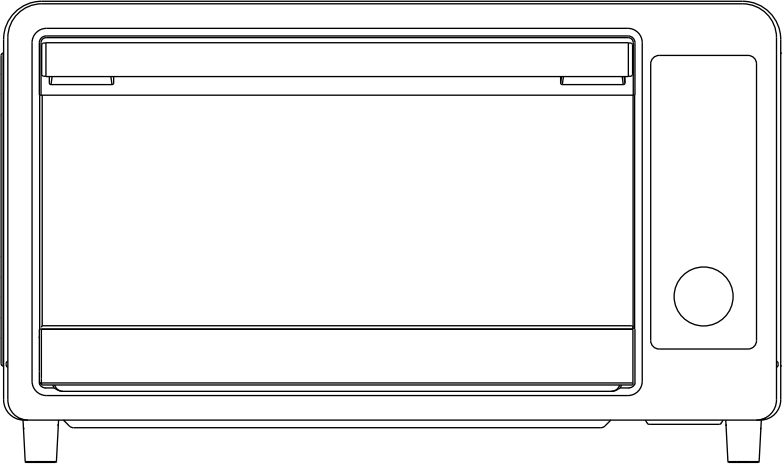

TOSHIBA

CONTENTS

PRODUCT SAFETY

IMPORTANT SAFEGUARDS	EN-3
SHORT CORD INSTRUCTION	EN-5

INSTRUCTION FOR USE

BEFORE FIRST USE	EN-5
NAME OF PARTS	EN-6
HOW TO USE	EN-7
CONTROL PANEL	EN-7
OPERATION	EN-8
MUTE	EN-8
AIRFRY	EN-8
AIRFRY MENU	EN-9
TOAST	EN-10
BAKE	EN-10
ROAST	EN-11
BROIL	EN-11
PIZZA	EN-12
WARM	EN-12
REHEAT	EN-13
DEHYDRATE.....	EN-13
CARE AND CLEANING	EN-14
SPECIFICATION	EN-14

MAINTENANCE

ONE YEAR LIMITED WARRANTY	EN-15
---------------------------------	-------



BEFORE OPERATING THIS PRODUCT,
READ, UNDERSTAND, AND FOLLOW THESE INSTRUCTIONS.
BE SURE TO SAVE THIS BOOKLIST FOR FUTURE REFERENCE



SAFETY WARNING

IMPORTANT SAFEGUARDS

When using electrical appliances, basic safety precautions should always be followed including the following :

1. Read all instructions.
2. Do not touch hot surfaces. Use handles or knobs.
3. To protect against electrical shock do not immerse cord, plugs, or any electrical parts in water or other liquid.
4. Close supervision is necessary when any appliance is used by or near children.
5. Unplug from outlet when not in use and before cleaning. Allow to cool before putting on or taking off parts.
6. Do not operate any appliance with a damaged cord or plug or after the appliance malfunctions or has been damaged in any manner. Return appliance to the nearest authorized service facility for examination, repair, or adjustment.
7. The use of accessory attachments not recommended by the appliance manufacturer may cause injuries.
8. Do not use outdoors.
9. Do not let cord hang over edge of table or counter, or touch hot surfaces.
10. Do not place on or near a hot gas or electric burner, or in a heated oven.
11. Extreme caution must be used when moving an appliance containing hot oil or other hot liquids.
12. Always attach plug to appliance first, then plug cord into the wall outlet. To disconnect, turn any control to "⊗", then remove plug from wall outlet.
13. Do not use appliance for other than intended use.
14. Use extreme caution when removing tray or disposing of hot grease.
15. Do not clean with metal scouring pads. Pieces can break off the pad and touch electrical parts, creating parts, creating a risk of electric shock.
16. Oversize foods or metal utensils must not be inserted in a toaster-oven as they may create a fire or risk of electric shock.
17. A fire may occur if the toaster-oven is covered or touching flammable material, including curtains, draperies, walls, and the like, when in operation. Do not store any item on top of the appliance when in operation.
18. Extreme caution should be exercised when using containers constructed of other than metal or glass.



SAFETY WARNING

IMPORTANT SAFEGUARDS

19. Do not store any materials, other than manufacturers recommended accessories, in this oven when not in use.
20. Do not place any of the following materials in the oven: (that is, paper, cardboard, plastic, and the like).
21. Do not cover crumb tray or any part of the oven with metal foil. This will cause overheating of the oven.
22. Caution-To ensure continued protection against risk of electric shock, connect to properly grounded outlets only.
23. Remove plug from outlet when the appliance is not in use, before putting on or taking off parts, and before cleaning. Allow to cool before handing.
24. Avoid contacting moving parts.
25. For household use only.
26. During operation, press " ⓧ " can stop cooking.

SAVE THESE INSTRUCTIONS



SAFETY WARNING

SHORT CORD INSTRUCTION **(DETACHABLE POWER-SUPPLY CORD)**

1. A short power-supply cord (or detachable power-supply cord) should be used to reduce the risk resulting from becoming entangled in or tripping over a longer cord.
2. Longer detachable power-supply cords or extension cords are available and may be used if care is exercised in their use.
3. If a longer detachable power-supply cord or extension cord is used:
 - The marked electrical rating of the cord set or extension cord should be at least as great as the electrical rating of the appliance.
 - The cord should be arranged so that it will not drape over the countertop or tabletop where it can be pulled on by children or tripped over unintentionally.
 - If the appliance is of the grounded type, the extension cord should be a grounding-type 3-wire cord.

BEFORE FIRST USE

1. Remove all accessories and packing materials before operating the oven.
 2. Wash the rack and grill tray in warm soapy water. Wipe the inside of the oven with a damp cloth or sponge. Blot dry with paper towels to be sure the unit is dry before using it.
 3. Place oven on a flat counter or other stable surface. **DO NOT OPERATE ON THE SAME CIRCUIT WITH ANOTHER APPLIANCE.**
 4. Make sure the crumb tray is properly installed before using it.
 5. Before working, place the crumb tray under the bottom heating pipes.
- For the first time only, set the temperature knob to MAX, the function setting on roast and the timer to 15 minutes. This will burn off any oils still on the oven.

NOTE

The oven may smoke during this process. This is normal for a new oven and will not last more than 10-15 minutes.

NAME OF PARTS

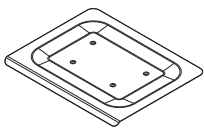
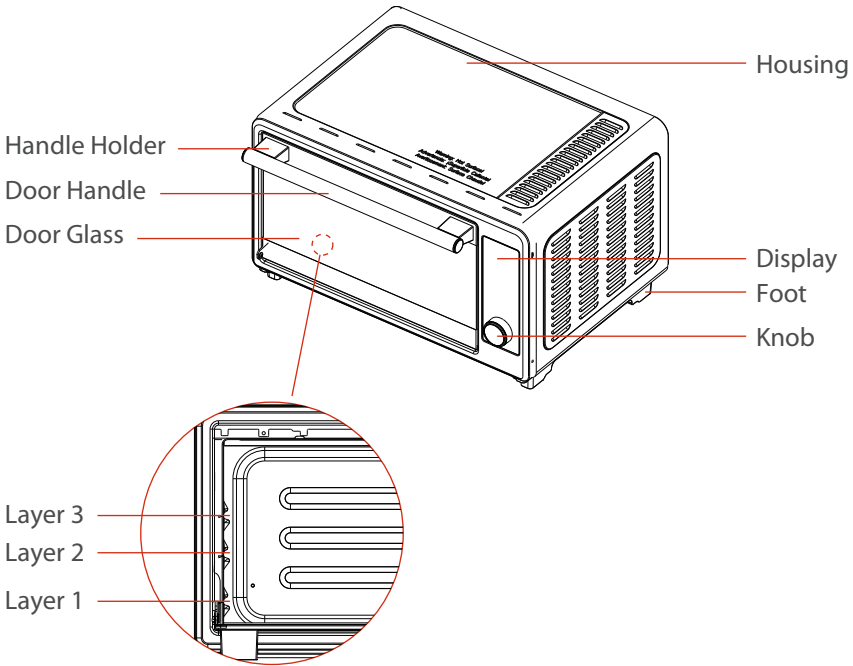

Crumb Tray

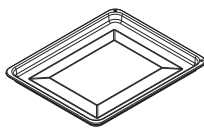

Grill Tray

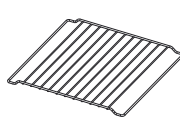

Rack

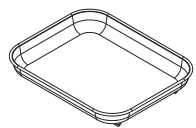

Fry Basket

HOW TO USE

CAUTION: THE OVEN SURFACES ARE HOT DURING AND AFTER USE GENERAL INSTRUCTIONS

1. Place the rack in position that will accommodate the height of the food to be cooked.
2. The food must be put into the grill tray to avoid the fire danger that caused by the accumulation of food chipping on the heating pipes.
3. Make sure that you always use an ovenproof container in the oven, never use plastic or cardboard containers in the oven.
4. Clean the heating pipe periodically.
5. Never use glass or ceramic pans or lids.
6. DO NOT let juice run to the bottom of the oven. Use the crumb tray when cooking.
7. Set the temperature as suggested by the recipe or as desired.
8. Securely shut the door and set the cooking time to begin operating the oven.
9. When you use the rack, please put the convex upward.
10. Please don't unplug the power cord when the oven finish working. The cooling fan will stop delay working 1 min.

CONTROL PANEL

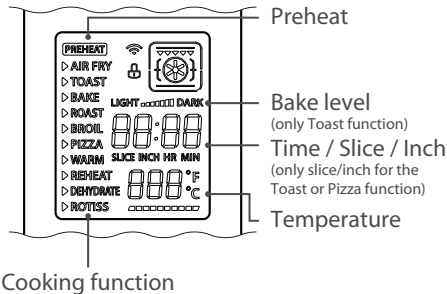

COOKING STEP

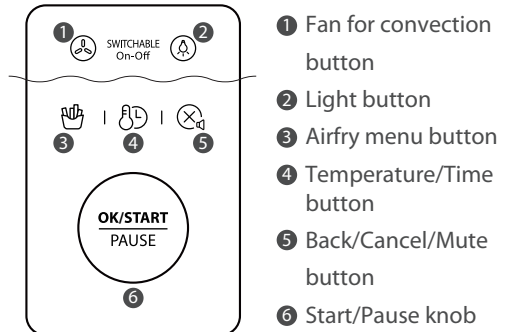

OPERATION

When the oven is powered, the buzzer will ring once. The default function is AIRFRY. In the process of cooking , you can press " OK/START/PAUSE " to pause cooking.

MUTE







When you want the oven to go silent, long press "⊗" for 3 seconds. The display screen will show "oFF". Then the machine will be in the mute function. And long press "⊗" 3 seconds, it will be cancel the mute function. The display screen will show "on".

AIRFRY

1. Turn on the power and machine is at original state. The default function is AirFry. " AIRFRY" and "⊗" will display on the display screen.
3. Press and rotate the "OK/START/PAUSE" knob to adjust the temperature. The default temperature is 410°F. This temperature is the cooking temperature after preheating.
4. Press the "⌚" button and rotate the "OK/START/PAUSE" knob to set the cooking time. The default cooking time is 15 minutes. This time is the cooking time after preheating.
5. Press the "OK/START/PAUSE" button to preheat.
6. After preheating, put the food into the cooking machine and close the door. Press the "OK/START/PAUSE" button to start cooking.
7. You can press the "⌚" button and rotate the "OK/START/PAUSE" knob to adjust the temperature and the time during cooking process.
8. After the cooking finishes, the machine will beep 3 times and the display screen will show "End". Pay attention to the high temperature of both the food and the machine when you take out the food.

OPERATION

AIRFRY MENU



1. When the function is AirFry, press the “” button once, it will into the AirFry menu. “AIRFRY”, A01” and “” will display on the display screen.
2. Rotate the “OK/START/PAUSE” knob and you can choose functions from A01-A08 in the menu. The default function is A01 (Chicken nuggets).
Note: if you choose A08 (frozen French fries), “A08” and “” will display on the display screen.
3. Press the “” button and rotate the “OK/START/PAUSE” knob to adjust the temperature. The default temperature of A01 is 410°F. This temperature is the cooking temperature after preheating.
4. Press the “” button and rotate the “OK/START/PAUSE” knob to set the cooking time. The default cooking time of A01 is 15 minutes 30 seconds. This time is the cooking time after preheating.
5. Press the “OK/START/PAUSE” button to preheat.
6. After preheating, put the food into the cooking machine and close the door. Press the “OK/START/PAUSE” button to start cooking. (If you choose A08 function, put French fries on the bottom of the fry basket. You are recommended to select the temperature and time shown on the menu. You also can adjust them after the cooking starts.)
7. You can press the “” button and rotate the “OK/START/PAUSE” knob to adjust the temperature and the time during cooking process.
8. After the cooking finishes, the machine will beep 3 times and the display screen will show “End”. Pay attention to the high temperature of both the food and the machine when you take out the food.

Display	AIR FRY Menu
A01	Chicken nuggets
A02	Breaded squid rings
A03	Breaded cod sticks
A04	Spring rolls





Display	AIR FRY Menu
A05	Potato cheese strips
A06	Vegetables
A07	Chicken leg
A08	Frozen french fries

OPERATION

TOAST





1. Rotate the "OK/START/PAUSE" knob to the right once. The display screen will show "TOAST" and "". Then the machine will be in the TOAST function.
2. Press and rotate the "OK/START/PAUSE" knob to choose the slice number of toast. The default number is 4 slices.
3. Press the " " button and rotate the "OK/START/PAUSE" knob to choose the degrees of toastiness. The default setting is 4.
4. Press the "OK/START/PAUSE" button to start cooking. The default cooking time is 4 minutes and 15 seconds, which cannot be adjusted during cooking process.
5. After the cooking finishes, the machine will beep 3 times and the display screen will show "End". Pay attention to the high temperature of both the food and the machine when you take out the food.

BAKE





1. Rotate the "OK/START/PAUSE" knob to the right twice. The display screen will show "BAKE" and "". Then the machine will be in the BAKE function. The fan is closed by default. You can open it by selecting " " and the " " icon will display.
2. Press and rotate the "OK/START/PAUSE" knob to adjust the temperature. The default temperature is 350°F.
3. Press the " " button and rotate the "OK/START/PAUSE" knob to adjust the cooking time. The default time is 25 minutes.
4. Press the "OK/START/PAUSE" button to start cooking.
5. After the cooking finishes, the machine will beep 3 times and the display screen will show "End". Pay attention to the high temperature of both the food and the machine when you take out the food.

OPERATION

ROAST





1. Rotate the "OK/START/PAUSE" knob to the right 3 times. The display screen will show "ROAST" and "". Then the machine will be in the ROAST function. The fan is closed by default. You can open it by selecting "" and the "" icon will display.
2. Press and rotate the "OK/START/PAUSE" knob to adjust the temperature. The default temperature is 350°F.
3. Press the "" button and rotate the "OK/START/PAUSE" knob to adjust the cooking time. The default time is 10 minutes.
4. Press the "OK/START/PAUSE" button to start cooking.
5. After the cooking finishes, the machine will beep 3 times and the display screen will show "End". Pay attention to the high temperature of both the food and the machine when you take out the food.

BROIL



1. Rotate the "OK/START/PAUSE" knob to the right 4 times. The display screen will show "BROIL" and "". Then the machine will be in the BROIL function. The fan is closed by default. You can open it by selecting "" and the "" icon will display.
2. Rotate the "OK/START/PAUSE" knob to adjust the temperature. The default temperature is 350°F.
3. Press the "" button and rotate the "OK/START/PAUSE" knob to adjust the cooking time. The default time is 10 minutes.
4. Press the "OK/START/PAUSE" button to start cooking.
5. After the cooking finishes, the machine will beep 3 times and the display screen will show "End". Pay attention to the high temperature of both the food and the machine when you take out the food.

OPERATION

PIZZA





1. Rotate the "OK/START/PAUSE" knob to the right 5 times. The display screen will show "PIZZA" and "". Then the machine will be in the PIZZA function.
2. Press and rotate the "OK/START/PAUSE" knob to choose pizza sizes, including 6 inches, 9 inches, and 12 inches. The default size is 9 inches.
3. Press the "" button and rotate the "OK/START/PAUSE" knob to adjust the temperature. The default temperature is 380°F for a 9-inch pizza.
4. Press the "" button and rotate the "OK/START/PAUSE" knob to adjust the cooking time. The default time is 10 minutes for a 9-inch pizza.
5. Press the "OK/START/PAUSE" button to preheat. "Preheat" will flash.
6. After preheating, put the food into the cooking machine and close the door. Press the "OK/START/PAUSE" button to start cooking.
7. Press the "" button and rotate the "OK/START/PAUSE" knob to adjust the temperature and the time during cooking process.
8. After the cooking finishes, the machine will beep 3 times and the display screen will show "End". Pay attention to the high temperature of both the food and the machine when you take out the food.

WARM



1. Rotate the "OK/START/PAUSE" knob to the right 6 times. The display screen will show "WARM" and "". Then the machine will be in the WARM function.
2. Press and rotate the "OK/START/PAUSE" knob to adjust the temperature. The default temperature is 180°F.
3. Press the "" button and rotate the "OK/START/PAUSE" knob to adjust the cooking time. The default time is 1 hour.
4. Press the "OK/START/PAUSE" button to start cooking.
5. After the cooking finishes, the machine will beep 3 times and the display screen will show "End". Pay attention to the high temperature of both the food and the machine when you take out the food.

OPERATION

REHEAT

1. Rotate the "OK/START/PAUSE" knob to the right 7 times. The display screen will show "REHEAT" and "". Then the machine will be in the REHEAT function. The fan is closed by default. You can open it by selecting "" and the "" icon will display.
2. Press and rotate the "OK/START/PAUSE" knob to adjust the temperature. The default temperature is 350°F.
3. Press the "" button and rotate the "OK/START/PAUSE" knob to adjust the cooking time. The default time is 3 minutes.
4. Press the "OK/START/PAUSE" button to start cooking.
5. After the cooking finishes, the machine will beep 3 times and the display screen will show "End". Pay attention to the high temperature of both the food and the machine when you take out the food.

DEHYDRATE

1. Rotate the "OK/START/PAUSE" knob to the right 8 times. The display screen will show "DEHYDRATE" and "". Then the machine will be in the DEHYDRATE function.
2. Press and rotate the "OK/START/PAUSE" knob to adjust the temperature. The default temperature is 150°F.
3. Press the "" button and rotate the "OK/START/PAUSE" knob to adjust the cooking time. The default time is 4 hours.
4. Press the "OK/START/PAUSE" button to start cooking.
5. After the cooking finishes, the machine will beep 3 times and the display screen will show "End". Pay attention to the high temperature of both the food and the machine when you take out the food.

CARE AND CLEANING

1. Before cleaning, unplug the oven and allow it to cool completely.
2. Wash all the attachments with mild, soaped water including the rack and the grill Tray.
3. Do not use abrasive cleansers, scrubbing brushes and chemical cleaner as these will cause damage to the non-stick coating of grill tray.
4. Using a wet cloth to wipe the inner of the oven.
5. To clean the door by using a wet cloth saturated with detergent or soap.
6. Never immerse the unit in water or other liquid.
7. Any other servicing should be performed by an authorized service representative.

CAUTION : HOT SURFACE

Warning: Hot Surface!
Advertencia: ¡Superficie Caliente!
Avertissement: Surface Chaude!

SPECIFICATION

MODEL	TL2-AC25CZA(GR)
CUBAGE	25L
VOLTAGE	120V~
AC FREQUENCY	60Hz
POWER	1750W

ONE YEAR LIMITED WARRANTY

This product carries a warranty stating that it will be free from defects in material and workmanship for a period of one year from the date of purchase. This warranty is valid for the original retail purchaser from the date of initial retail purchase and is not transferable. Keep your original sales receipt.

IMPORTANT:

1. This warranty does not cover damages resulting from accident, misuse or abuse, lack of reasonable care, the affixing of any attachments not provided with the product, loss of parts, or subjecting the appliance to any but the specified voltage. (Read directions carefully.)
2. This warranty is void if this product is ever used for other than private household purposes.
3. This warranty is void if this product is ever used outside of United State.

If service is required during the warranty period, properly pack your unit. We recommend using the original carton and packing materials.

If additional assistance is needed, please contact customer assistance at:

customercare@us.toshiba-lifestyle.com

855-204-5313

Midea America Corp

5 Sylvan Way,

Parsippany, NJ 07054

Midea America Corp. expressly disclaims all responsibility for consequential damages or incidental losses caused by use of the appliance. Some states do not allow this exclusion or limitation of incidental or consequential losses so the foregoing disclaimer may not apply to you. This warranty gives you specific legal rights, and you may also have other rights which may vary from state to state.

The serial number can be found on the back cabinet. We suggest that you record the serial number of your unit in the space below for future reference

Model Number: _____

Serial Number: _____

SAVE THIS FOR YOUR RECORDS

Customer Assistance: 855-204-5313

Midea America Corp

5 Sylvan Way, Parsippany, NJ 07054