

TOSHIBA

FRONT LOADING WASHING MACHINE

OWNER'S MANUAL

MODEL:

TWD-BM105GF4S

TWD-BM115GF4S

TWD-BM135GF4S

Read This Manual

Read and follow the instructions carefully.
Keep the operation instructions handy for
future use .

CONTENTS

SAFETY INSTRUCTIONS

- Safety Instructions2

INSTALLATION

- Product Description9
- Installation10

OPERATION

- Quick Start13
- Before Each Washing15
- Detergent Dispenser16
- Control Panel 17
- Programmes.....18
- Option..... 23

MAINTENANCE

- Cleaning and Care27
- Trouble Shooting30
- Technical Specifications31
- Product Fiche 32

SAFETY INSTRUCTIONS

■ Safety Instructions

Please read the following safety information thoroughly and follow it strictly to minimize the risk of fire or explosion, electric shock and to prevent property damage, personal injury or loss of life. Failing to follow these instructions shall void any warranty.

Warning!

This combination of symbol and signal word indicates a potentially dangerous situation which may result in death or serious injuries unless it's avoided.

Caution!

This combination of symbol and signal word indicates a potentially dangerous situation which may result in slight or minor injuries or damage to property and the environment.

Note!

This combination of symbol and signal word indicates a potentially dangerous situation which may result in slight or minor injuries.

Warning!

ELECTRIC SHOCK HAZARD

- If the supply cord is damaged, it must be replaced by the manufacturer, its service agent or similarly qualified persons in order to avoid a hazard.
 - If the machine is damaged, it must not be operated unless repaired by the manufacturer, its service agent or similarly qualified persons.
- Risk of electric shock!

SAFETY INSTRUCTIONS

- The appliance can be used by children aged from 8 years and above and persons with reduced physical, sensory or mental capabilities or lack of experience and knowledge if they have been given supervision or instruction concerning use of the appliance in a safe way and understand the hazards involved. Children shall not play with the appliance. Cleaning and user maintenance shall not be made by children without supervision.
- Children should be supervised that they do not play with the appliance.
- Children 3 years and under shall be kept away from the appliance or continuously supervised.
- Animals and children may climb into the machine. Check the machine before every operation.
- Do not climb or sit on the appliance.

INSTALLATION LOCATION AND SURROUNDING

- All washing and additional substances are to be kept in a safe place out of the reach of children.
- Do not install the machine on a carpet floor. The obstruction of the openings by a carpet can damage the machine.
- Keep the appliance clear from heating sources and direct sunlight to avoid plastic and rubber parts to corrode.
- Do not use the appliance in humid environments or rooms containing explosive or caustic gas. In case of water leakage or water splashes let the appliance dry in the open air.
- The appliance must not be installed behind a lockable door, a sliding door or a door with a hinge on the opposite side to that of the washer dryer.

SAFETY INSTRUCTIONS

- Do not operate the machine in rooms with a temperature of below 5°C. This can cause damages to parts of it. If it is unavoidable, make sure to drain the water completely from the appliance after every use (see „Maintenance - Cleaning of drain pump filter“) to avoid damages caused by frost.
- Never use flammable sprays or substances in the immediate proximity of the appliance.

INSTALLATION

- Remove all packaging material and transport bolts before using the appliance. Otherwise, serious damage may result.
- This appliance is equipped with a single inlet valve and can be connected to the cold water supply only.
- Mains plug must be accessible after installation.
- Before washing clothes for the first time, the product shall be operated once throughout all the procedures without any clothes inside.
- Before using the washer dryer, the product shall be calibrated.
- Do not put any excessively heavy objects on the appliance, like water containers or heating devices.
- The new hose-sets supplied with the appliance are to be used and that old hose-sets should not be reused.
- Max. Inlet water pressure 1MPa. Min. inlet water pressure

ELECTRICAL CONNECTION

- Make sure the supply cable is not trapped by the machine, it can get damaged.
- Connect the product to a grounded outlet protected by a fuse complying with the values in the “Technical specifications“ table. The grounding installation has to be made by a qualified electrician. Ensure that the machine is installed in accordance with the local regulations.

SAFETY INSTRUCTIONS

•Water and electrical connections must be carried out by a qualified technician in accordance with the manufacturer's instructions and local safety regulations.

Warning!

- Don't use multiple plugs or extension cords.
- The appliance must not have an external switching device such as a timer or connected to a circuit that is regularly switched on and off.
- Do not pull the plug out of the mains outlet if there is flammable gas around.
- Never pull out power plug with wet hands.
- Always pull at the plug, not at the cable.
- Always unplug the appliance if it is not being used.

WATER CONNECTIONS

- Check the connections of the water inlet tubes, the water tap and the outlet hose for possible problems due to changes of water pressure. If the connections loosen or leak close the water tap and get it repaired. Do not use the appliance before the pipes and hoses are installed properly by qualified persons.
- Glass door may become very hot during the operation. Keep children and pets far away from the machine while it is operating.
- The water inlet and outlet hoses have to be safely installed and remain undamaged. Otherwise, water leakage can occur.
- Do not remove the drain pump filter while there is still water in the appliance. Big quantities of water can leak out, and

SAFETY INSTRUCTIONS

OPERATION AND MAINTENANCE

Warning!

- Never stop the washer dryer before the end of the drying cycle unless all items are quickly removed and spread out so that the heat can dissipate.
- The washer dryer is not to be used if industrial chemicals have been used for cleaning. Risk of explosion.

- Never use any flammable, explosive or toxic solvents. Do not use gasoline and alcohol etc. as detergents. Only select detergents that are suitable for machine washing.
- Make sure that all pockets are emptied. Sharp and rigid items such as coins, brooches, nails, screws, stones etc. may cause serious damages to this machine.
- Remove all objects from pockets such as lighters and matches before use the appliance.
- Thoroughly rinse items that have been washed by hand.
- Do not dry unwashed items in the appliance.
- Items that have been soiled with substances such as cooking oil, acetone, alcohol, petrol, kerosene, spot removers, turpentine, wax and wax removers should be washed in hot with an extra amount of detergent before being dried in the appliance.
- Items containing foam rubber (latex foam), shower caps, water proof textiles, rubber backed articles and clothes or pillows fitted with foam rubber pads should not be dried in the machine
- Fabric softeners or similar products should be used as recommended in their instructions.
- Never try to open the door forcefully. The door will unlock shortly after the end of a cycle.
- Please do not close the door with excessive force. If it is found difficult to close the door, please check if the clothes

SAFETY INSTRUCTIONS

- Always unplug the appliance and close the water tap before cleaning and maintenance and after each use.

- Never pour water over the appliance for cleaning purpose.

Risk of electric shock!

- Repairs shall only be carried out by the manufacturer, its service agent or similarly qualified persons in order to avoid a hazard. The producer will not be responsible for damages caused by the intervention of not authorized persons.

TRANSPORT

- Before Transport:

- Bolts shall be reinstalled to the machine by a specialized person

- Accumulated water shall be drained out of the machine

- This appliance is heavy. Transport with care. Never hold any protruding part of the machine when lifting. The machine door

INTENDED USE

The product is intended only for home use and for textiles in household amounts suitable for machine washing and drying.

This appliance is for indoor use only and not intended for built in use. Only use according to these instructions. The

appliance is not intended for commercial use.

Any other use is considered as improper use. The producer is not responsible for any damage or injuries that may result of

It This appliance is intended to be used in household and similar applications such as:

- Staff kitchen areas in shops, offices and other working environments

- Farm houses;

- By clients in hotels, motels and other residential type environments;

- Bed and breakfast type environments;

- Areas for communal use in blocks of flats or in launderettes.

SAFETY INSTRUCTIONS

Packaging/Old appliance



This marking indicates that this product should not be disposed with other household wastes throughout the EU. To prevent possible harm to the environment or human health from uncontrolled waste disposal, recycle it responsibly to promote the sustainable reuse of material resources. To return your used device, please use the collection systems or contact the retailer where the product was purchased. They return and can take this product for environmental safe recycling.

INSTALLATION

■ Product Description

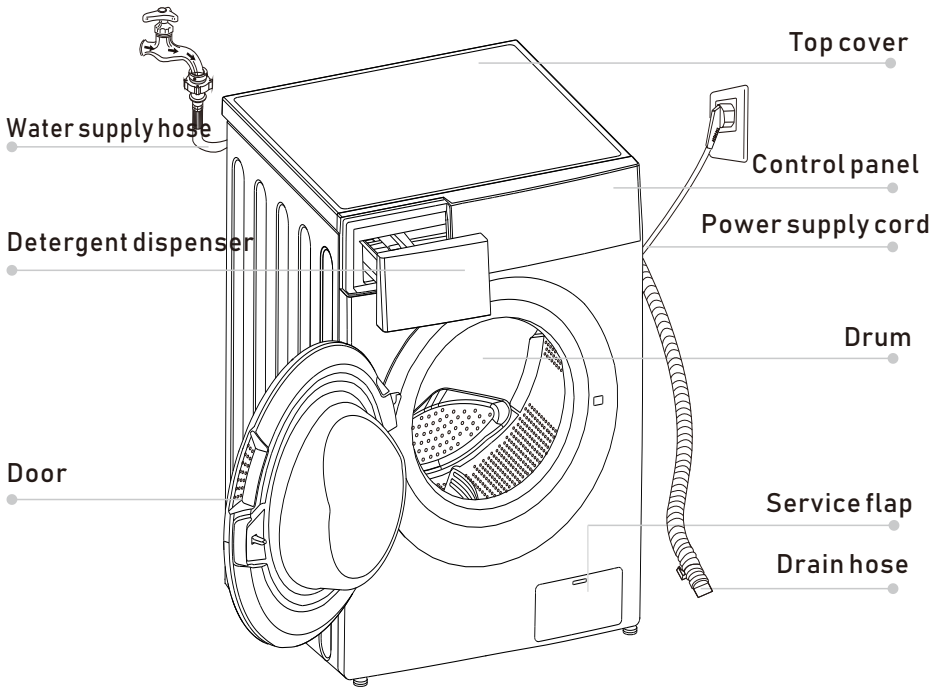

📌 Note!

- The product picture is for illustration only, please refer to real product as reference.

Accessories

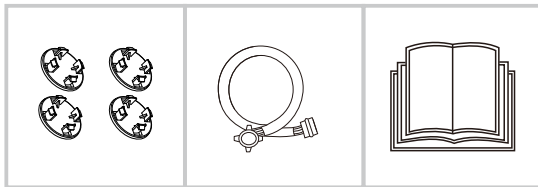

4 x Cover caps

1 x Supply hose
1 x Owner's manual
cold water

INSTALLATION

■ Installation

Installation area

⚠ Warning!

- Stability is important to prevent the product from wandering! Make sure the machine is standing leveled and stable.
- Make sure that the product does not stand onto the power cord.
- Make sure to maintain the minimum distances from the walls as shown in the picture

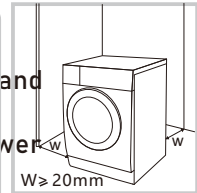

Before installing the machine, the location characterized as follows shall be selected:

1. Rigid, dry, and level surface
2. Avoid direct sunlight
3. Sufficient ventilation
4. Room temperature is above 0°C
5. Keep far away from the heat sources such as coal or gas burning appliances.

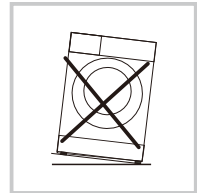

Unpacking the washer dryer

⚠ Warning!

- Packaging material (e.g. Films, Styrofoam) can be dangerous for children.
- There is a risk of suffocation! Keep all packaging well away from children.

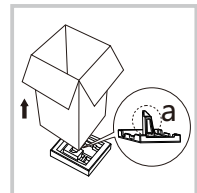

1. Remove the cardboard box and styrofoam packing.
2. Lift the washer dryer and remove the base packaging. Make sure the small triangle foam (a) is removed with the bottom packaging together. If not, lay the unit down on the side surface and remove it manually.
3. Remove the tape securing the power supply cord and drain hose.
4. Remove the inlet hose from the drum.

INSTALLATION

Remove transport bolts

⚠ Warning!

- You must remove the transport bolts from the backside before using the product.



Loosen the 4 transport bolts with a spanner.

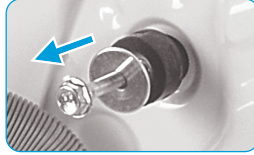

Remove the bolts including the rubber parts and keep them for future use.

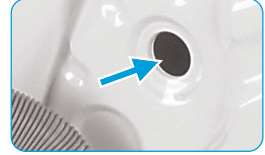

Close the holes using the cover caps.

Levelling the washer dryer

⚠ Warning!

- The lock nuts on all four feet must be screwed tightly against the housing.

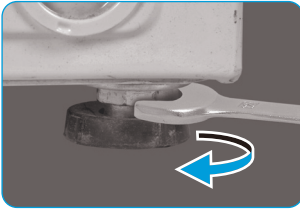

1. Loosen the lock nut.
2. Turn the foot until it reaches the floor.
3. Adjust the legs and lock the nuts with a spanner. Make sure the machine is level and steady.

Connect the water supply hose

⚠ Warning!

To prevent leakage or water damage, follow the instructions in this chapter

- Do not kink, crush or modify water inlet hose.

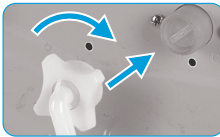

Connect the water supply hose to the water inlet valve and a water tap with cold water as indicated.



🔧 Note!

- Connect manually, do not use tools. Check if the connections are tight.

INSTALLATION

Drain Hose

⚠ Warning!

- Do not kink or protract the drain hose.
- Position drain hose properly ,otherwise damage might result of water leakage.

There are two ways to place the end of drain hose:

1.Put it into the water trough.

2.Connect it to the branch drain pipe of the trough.

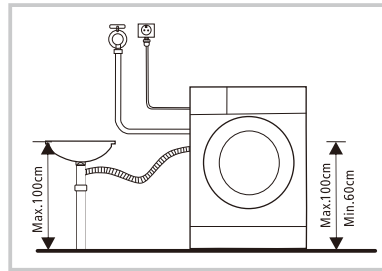
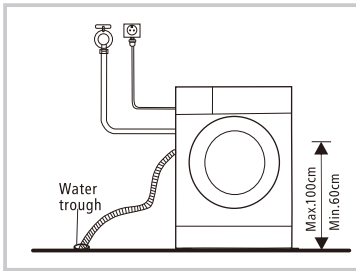

OPERATION

■ Quick Start

⚠ Caution!

- Before washing, please make sure the washer dryer is installed properly.
- Your appliance was thoroughly checked before it left the factory. To remove any residual water and to neutralize potential odors, it's recommended to clean your appliance before first use. For this reason, start the Cotton program at 90°C without laundry and detergent.

📌 Calibration

It's recommended to calibrate the washer dryer, so that provide the best performance.

The appliance is able to detect the amount of laundry loaded. This function is optimizing the product performance by minimizing energy and water consumption, saving you money and time. For this reason it's recommended to calibrate the appliance for best use.

- 1- Remove all accessories from the drum and close the door;
- 2- Insert the mains plug to the socket;
- 3- Switch on the washer dryer and press "Temp." and "Dry." simultaneously for 10 seconds until "t19" is displayed;
- 4- Press  to start the appliance and wait till "****" is displayed.

OPERATION

1. Before Washing

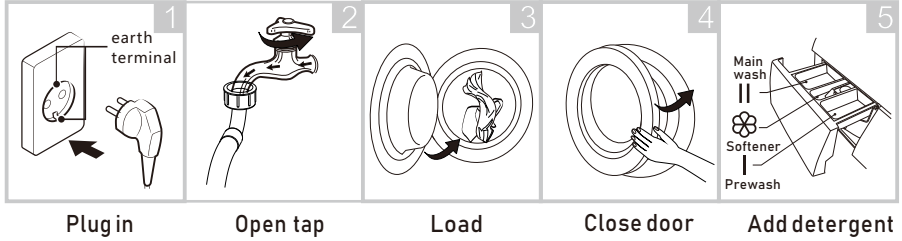

Note!

- Detergent need to be added in compartment I if the pre-wash function is selected.

2. Washing

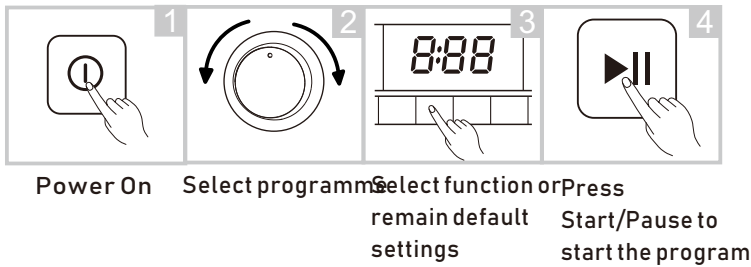

3. After Washing

Buzzer beep and “End” on display.

OPERATION

■ Before Each Washing

- The ambient temperature of the washer dryer should be 5-40°C. If used under 0°C, the inlet valve and draining system may be damaged. If the machine is installed under freezing conditions, it should be transferred to normal ambient temperature to ensure the water supply hose and drain hose can unfreeze before use.
- Please check your laundry care labels and the detergent use instructions before wash. Use non-foaming or less-foaming detergent suitable for machine washing properly.

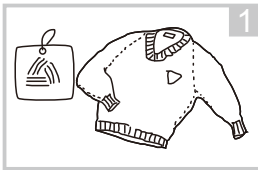

Check the care label

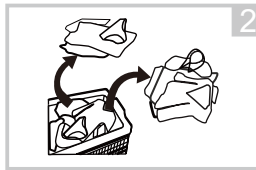

Sort laundry according to color and textile type

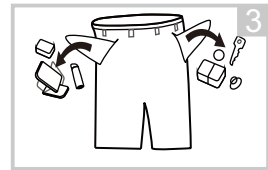

Take all items out of the pockets

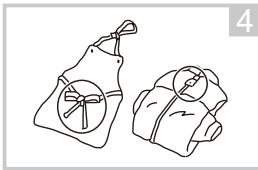

Tie together long textile strips and belts, close zips and button

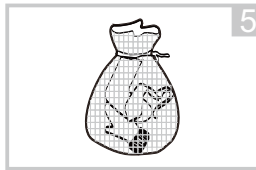

Put small items into a laundry bag

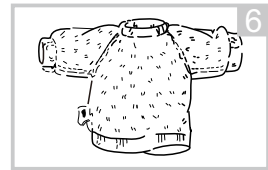

Turn easy-pilling and long-pile fabric inside out

⚠ Warning!

- Do not wash or dry articles that have been cleaned in, washed in, soaked in, or dabbed with combustible or explosive substances like wax, oil, paint, gasoline, alcohol, kerosene, and other flammable materials.
- Washing single clothes items may easily create big eccentricity and cause alarm due to unbalance. Therefore it is suggested to add one or two more laundry items to the wash so that spin can be done smoothly.

OPERATION

■ Detergent Dispenser

- I Pre wash
- II Main wash
- ☼ Softener
- ⊖ Release button to pull out the dispenser

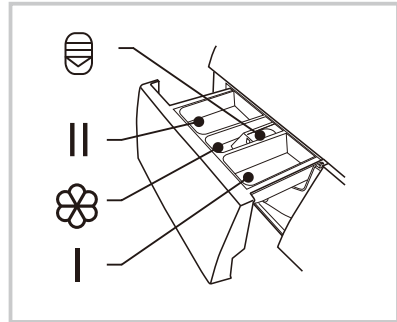

⚠ Caution!

- Detergent only need to be added in "compartment I" after selecting pre-wash function.

| Programme | I | II / Δ | ☼ | Programme | I | II / Δ | ☼ |
|--------------|---|--------|---|--------------|---|--------|---|
| Cotton | ○ | ● | ○ | Rinse & Spin | | | ○ |
| Mix | ○ | ● | ○ | Wool | | ● | ○ |
| Baby Care | ○ | ● | ○ | ECO 40-60 | | ● | ○ |
| 20°C | | ● | ○ | Intensive | | ● | ○ |
| Drum Clean | | | | Quick15' | | ● | ○ |
| Spin Only | | | | Dry Only | | | |
| Wash and Dry | | ● | ○ | 1h W/D | | ● | ○ |

- Means must ○ Means optional

📌 Note!

- As for the agglomerated or ropy detergent or additive, before they are poured into the detergent box, it is suggested to use some water for dilution to prevent the inlet of detergent box from being blocked and overflowing while filling water.
- Please choose suitable type of detergent for the various washing temperature to get the best washing performance with less water and energy consumption.

OPERATIONS

Control Panel

Model: TWD-BM105GF4S; TWD-BM115GF4S; TWD-BM135GF4S



Note!

- The chart is for reference only, Please refer to real product as standard.

1 On/Off

Product is switched on or off.

2 Start/Pause

Press the button to start or pause the washing cycle.

3 Option

This allows you to select an additional function and will light when selected.

4 Programmes

Available according to the laundry type.

5 Display

The display shows the settings, estimated time remaining, options, and status messages for your washer. The display will remain on through the cycle.

A UFB-WiFi-Remote control-
Door lock-Child lock-Delay end

B Wash Time Delay EndTime Error End
0:55 2h E20 End

C Detergent-Softener
Speed Wash-Extra rinse-Prewash

D Steam

E Time Dry-Dry-Extra Dry

OPERATION

■ Programmes

Model: TWD-BM105GF4S; TWD-BM115GF4S; TWD-BM135GF4S

| Programme | Load(kg) | | Default Time | |
|----------------|----------|----------|--------------|------|
| | 10.0 | 12.0 | 10.0 | 12.0 |
| ☀ COTTON | 10.0/7.0 | 12.0/8.0 | 1:18 | |
| ☀ GREATWAVES | 10.0/7.0 | 12.0/8.0 | 3:47 | |
| ☀ MIX | 5.0/5.0 | 6.0/6.0 | 1:10 | |
| ECO WASH | 10.0 | 12.0 | 0:55 | |
| SPIN ONLY | 10.0 | 12.0 | 0:12 | |
| DRUM CLEAN | - | - | 1:18 | |
| ☀ MEMORY | 10.0/7.0 | 12.0/7.0 | 1:18 | |
| ☀ QUICK 12' | 2.0/1.0 | 2.0/1.0 | 0:12 | |
| ☀ TIME DRY | 7.0/7.0 | 8.0/8.0 | 0:30 | |
| ☀ DRY ONLY | 10.0/7.0 | 12.0/8.0 | 3:00 | |
| WOOL | 2.0 | 2.0 | 1:07 | |
| ☀ ANTI-ALLERGY | 10.0/7.0 | 12.0/8.0 | 4:31 | |



Note!

OPERATION





































































■ Programmes

Programmes are available according to the laundry type.

| Programmes | |
|--------------|---|
| COTTON | Hard-wearing textiles, heat-resistant textiles made of cotton or linen. |
| MEMORY | Press [Temp.] and [Spin] 3sec. for my cycle to memory the procedure. The default my cycle is cotton. |
| MIX | Mixed load consisting of textiles made of cotton and synthetics. / |
| ECO 40-60 | Default 40°C, not selectable, suitable for laundry washing at about 40°C-60°C. |
| QUICK 12' | This procedure is suitable for washing few and not very dirty clothes quickly. |
| ANTI-ALLERGY | This program applies 60°C high temperature sterilization to make the clothes washing more clean. to achieve the anti-allergy effect. |
| WOOL | Hand or machine-washable wool or richwool textiles. Especially gentle wash programme to prevent shrinkage, longer programme pauses (textiles rest in wash liquor). |
| SPIN ONLY | Extra spin with selectable spin speed. |
| DRUM CLEAN | Specially set in this machine to clean the drum and tube. It applies 90 °C high temperature sterilization to make the clothes washing more green. When this programme is performed, the clothes or other washing cannot be added. When proper amount of chlorine bleaching agent is put in, the barrel cleaning effect will be better. The customer can use this programme regularly according to the need. |
| DRY ONLY | Select it to dry clothes, the temperature is different. The drying time according to the load. |
| WASH AND DRY | The standard energy program. |

* "Cotton program, 60°C water temperature, 1400 RPM." is the recommended washing program designed to minimize water consumption for normally soiled load at rated capacity.

Model: TWD-BM105GF4S; TWD-BM115GF4S; TWD-BM135GF4S

| Cycle | Default Temp.(°C) | Default spin speed in rpm | Additional functions |
|--------------|-------------------|---------------------------|---|
| 1400 | | | |
| COTTON | 40 | 1000 |           |
| GREATWAVES | 20 | 1000 |          |
| MIX | 40 | 1000 |           |
| ECO WASH | 30 | 800 |     |
| SPIN ONLY | - | 1000 |  |
| DRUM CLEAN | 90 | -- |  |
| MEMORY | 40 | 1000 |           |
| QUICK12' | cold | 800 |    |
| TIME DRY | - | 0 |     |
| DRY ONLY | - | 0 |     |
| WOOL | 40 | 600 |     |
| ANTI-ALLERGY | 60 | 800 |         |

OPERATION

■ Option

Delay

Delay

Set the Delay function:

1. Select a programme;
2. Press the Delay button to choose the time (the delaying time is 0-24 H.);
3. Press [Start/Pause] to commence the delay operation



Choose the Programme Setting time

Start

Cancel the Delay function:

Press the [Delay] button until the display be 0H. It should be pressed before starting the programme. If the programme already started, should switch off programme to reset a new one.

⚠ Caution!

- If there is any break in the power supply while the machine is operating, a special memory stores the selected programme and when the power is restarted, the program will continue.

Pre Wash

Pre Wash

The Prewash function can get an extra wash before main wash, it is suitable for washing the dust rises to surface of the clothes; You need to put detergent into the Case (I) when select it.

Extra Rinse

Extra Rinse

The laundry will undergo extra rinse once after you select it.

Speed Wash

Speed Wash

The function can decrease the washing time.



My Cycle

To memory the frequently used programme.

After choosing the programme and setting the options, press [Temp.] 3 sec. before start to wash. The default setting course is Cotton.

Temp.

Temp.

Press the button to regulate the temperature (Cold, 20°C, 30°C, 40°C, 60°C, 90°C)

Speed

Speed

Press the button to change the speed.

1400: 0-400-600-800-1000-1200-1400 1500: 0-400-600-800-1000-1200-1400-1500

OPERATION



Reload

This operation can be executed during the washing progress. When the drum is still rolling and there is large amount of water with high temperature in the drum. The state is unsafe and the door cannot be opened forcefully. To press [Start/Pause] for 3 sec. to reload, and start the clothes adding in the midway function. Please follow the steps as bellow:

- 1.Wait until the drum stops rotation.
- 2.The door lock is unlocked.
- 3.Close the door when the clothes are reloaded and press the [Start/Pause] button.



Press[Start/Pause]3sec.

Reload the clothes

Start

SpaCare

SpaCare

SpaCare function can be selected by choose “Cotton”, “Mix” “Bed Linen” and “Baby Care”.

The customers can see the steam in the drum when operate SpaCare function. The SpaCare cannot be used simultaneously With Pre Wash and Speed Wash.

⚠ Caution!

- Don't use the Reload function when the water level over the edge of the inner tub or the temperature is higher.

OPERATION



Child Lock

To avoid mis operation by children.



Press [Delay] and [SpaCare]
3 sec. till buzzer beep.

⚠ Caution!

When child lock is activated and program starts, child lock indicator will switch on, and the CL and remaining time on the display are alternately displayed in 0.5s.

Press the other buttons will make child lock indicator flash for 3s. when program finish, CL and END alternate for 10s in 0.5s, then the child lock lights flash for 3s

- Only press and hold the two button can release child lock, even power off, switch off and program end
- The "Child Lock" will lock all buttons except Power button and Child Lock button
- Please release child lock before selecting program and staring washing



Mute the buzzer



Choose the Programme



Press the [Speed] button for 3sec.,
the buzzer is mute.

To act the buzzer function, press the button again for 3 seconds. The setting will be kept until the next reset.

⚠ Caution!

- After Muting the buzzer function, the sounds will not be activated any more.



Dry

Press the Dry button continuously to choose the dry level: Extra Dry/Normal Dry (Normal)/ Gentle Dry(Soft).

- ≡ Extra Dry: Need to wear clothes immediately, we can choose this function;
- = Normal Dry(Normal): The normal dry procedure;
- Gentle Dry(Soft): Only to dry slightly and then is just ok;
- 🕒 Timed Dry: We can choose this function to dry clothes for a specific time.

OPERATIONS



Wi-Fi

Touch the “Wi-Fi” for 3 seconds, the washing machine will be connected to the internet on your smartphone. The details of Wi-Fi connect, please check page 24. This is the Wi-Fi switch, if you want to make your appliance connect to the internet. You need to turn on the “Wi-Fi” button. The working frequency is 2.4GHz-2.4385GHz, working voltage is $5V \pm 5\%$, working temperature is 0 -85



REMOTE

This is the switch of remote control, if you want to use your smartphone to control the washing machine remotely, you need to touch “REMOTE” button. Considering the safe operation of the washing machine, the smartphone remote control should meet the following conditions:

1. The appliance should connect to the internet;
2. The door of upper drum & under drum should be closed.

Remark:

- If the door is open in any time, the remote control function will be failure.
- The remote control function is turned off at the end of each cycle automatically, if you want to use remote control function again, you need to turn it on again.

Wi-Fi INFORMATION

| | |
|---|-------------------------------|
| Wireless technology and Working Frequency | 2.4G |
| Wireless modulation Type | CCK OFDM GFSK |
| Antenna Type & Gain | PCB Antenna 0dBi |
| Extreme Temperature Range | -20 ~85 |
| Max RF Power Output | WI-FI: E.I.R.P 18dBm BT: 8dBm |

OPERATIONS

■ Instructions to Connection with Toshiba HA App

Before you start, make sure that:

1. Your smartphone is connected to home WiFi network, and you know the network password.
2. You are next to the appliances.
3. The frequency of your wireless router is 2.4GHz (preferable) or 5GHz.
4. Initiate your mobile phone's Bluetooth and allows the APP to find your phone.

- 1** Download Toshiba HA App
Scan the QR code below or search for "Toshiba HA" in Google Play(Android devices) or App Store(ios devices) to download the app.



- 2** Register or Login account
Open the App and create a user account. If you already have one, just log in



- 3** Add your appliance
Click the "+" button, add your device according to the device model or search the device found out by Bluetooth and add it.



- 4** Connected to the network
Follow the instructions in the App to set up the WiFi connection. If the network connection fails, please refer to the App tips for operation.



⚠ Notes on Connection

- When networking the product, please make sure that the mobile phone is as close as possible to the product.
- According to the App tips, if the appliance could only connect to the 2.4GHz WiFi network, please note that the 2.4GHz network is now available.
- Toshiba recommends that you would better name your WiFi router SSID with letters and numbers only; otherwise, the SSID might become invalid if it is named with special characters, punctuation marks or spaces. After the SSID is available, please try to connect with WiFi, otherwise, please login the router and change the SSID name.
- If there is a large number of devices connecting with the WiFi router, the network stability might be affected. Toshiba is not obliged to advise you that how many devices you shall connect you're your WiFi router, for it depends on router quality and many other factors.
- If the router is replaced or WiFi name or password is revised, please carry out the steps abovementioned again for WiFi connection.
- When the product technology is updated, Toshiba HA may be changed, but what the content shown in the Toshiba HA shall prevail.

MAINTENANCE

■ Cleaning and Care

⚠ Warning!

- Always unplug the appliance and close the water tap before cleaning and maintenance.

Cleaning the Cabinet

Proper maintenance on the washing machine can extend its working life. The surface can be cleaned with diluted non-abrasive neutral detergents when necessary. If there is any water overflow, use a cloth to wipe it off immediately. Never use sharp items to clean the appliance.

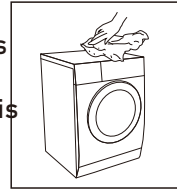

⚠ Caution!

- Never use abrasive or caustic agents, formic acids or its diluted solvents or similar substances, like alcohol or chemical products.

Cleaning the Drum

Any rust stains left inside the drum by metal articles must be removed immediately using chlorine-free detergents. Never use steel wool for cleaning the drum!

📌 Note!

- Keep any laundry away from the machine while cleaning the drum.

Cleaning the Door Seal and Glass

Wipe the glass and seal after each wash to remove lint and stains. If lint builds up it can cause leakages.

Remove any coins, buttons and other objects from the seal after each wash.

Clean the Door Seal and Glass every month to ensure the normal operation of the appliance.

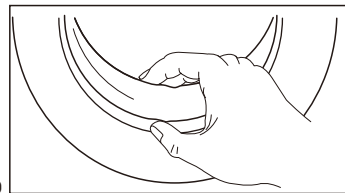

MAINTENANCE

Cleaning the Inlet Filter

Note!

- Diminishing water flow is a sign that the filter need to be cleaned.

1. Close the tap and remove the water supply hose from it.
2. Clean the filter with a brush.
3. Unscrew the water supply hose from the backside of the machine. Pull out the filter with long nose pliers.
4. Use a brush to clean the filter.
5. Reinstall the filter to the water inlet and reconnect the water supply hose.
6. Clean the Inlet filter every 3 months to ensure the normal operation of the appliance.

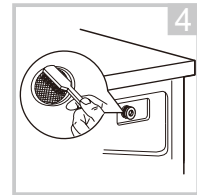
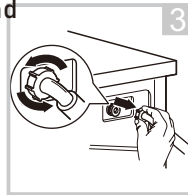
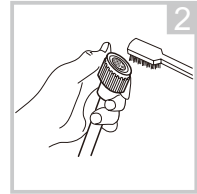
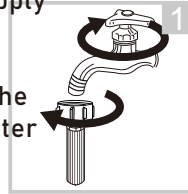

Clean The Detergent Dispenser

1. Press down the release  on the softener cover and pull the dispenser drawer out of the recess. Clean the inside of the recess with a brush.
2. Lift the softener cover off the dispenser drawer and wash both items with water.
3. Restore the softener cover and push the drawer back into the recess.

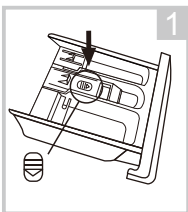

Press the release and remove the dispenser drawer

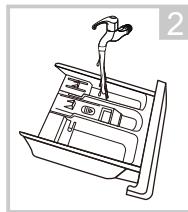

Clean the dispenser drawer and the softener cover under water

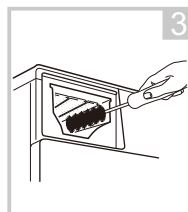

Clean the recess with a soft brush

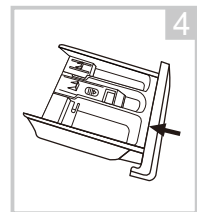

Insert the dispenser drawer

Note!

- Do not use abrasive or caustic agents to clean plastic parts.

MAINTENANCE

Cleaning the Drain Pump Filter

⚠ Warning!

- Make sure that the machine has finished the washing cycle and is empty. Switch it off and unplug it before cleaning the drain pump filter.
- Be careful of hot water. Allow the water to cool down. Risk of scalding!
- Clean the filter periodically every 3 months to ensure the normal operation of the appliance.

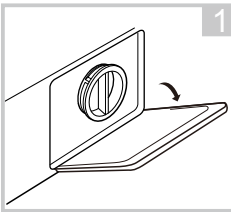

Open the lower cover cap

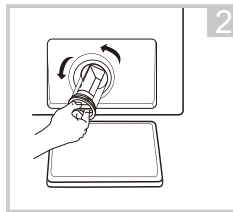

Open the filter by turning to the counter clockwise

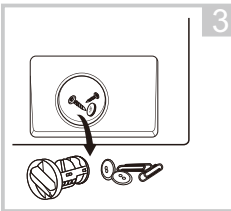

Remove extraneous matter

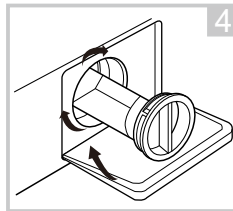

Close the lower cover cap

⚠ Caution!

- When the appliance is in use and depending on the programme selected there can be hot water in the pump. Never remove the pump cover during a wash cycle, always wait until the appliance has finished the cycle, and is empty. When replacing the cover, ensure it is securely re-tightened.

MAINTENANCE

■ Trouble Shooting

Whenever there is a problem with the appliance, check if you can solve it following the tables below. If the problem persists, please contact the customer service.

| Description | Possible cause | Solution |
|---|--|---|
| Appliance does not start | Door is not closed properly. Clothes are stuck. | Close the door properly and restart. Check the laundry. |
| Door can't be opened | Safety protection is activated. | Disconnect the power and restart. |
| Water leakage | Connections are not tight enough. | Check and fasten the water inlet pipe. Check and clean the outlet hose. |
| Detergent residues in the detergent dispenser | Detergent is damp and/or clotted. | Clean and wipe the detergent dispenser dry. |
| Indicator or display does not work | PC board or harness have connection problems. | Switch off the power and check if the mains plug is connected properly. |
| Abnormal noise | Fixing bolts still in place. Floor is not solid or level. | Check if the fixing bolts have been removed Make sure the appliance is installed on a solid and level floor. |

Error Codes

| Description | Possible cause | Solution |
|-------------|--|--|
| E30 | Door is not closed properly | Close the door properly and restart. |
| E10 | Water injecting problem during wash cycle. | Check if the water pressure is high enough. Straighten the water pipe. Clean the inlet valve filter. |
| E21 | Overtime water draining | Check the drain hose for blockage. |
| E12 | Water overflow | Restart the appliance. |
| EXX | Others | Restart the appliance. If problem persists, please contact the customer service. |

MAINTENANCE

■ Customer service

Spare part for your appliance are available for a minimum of 10 years.
In case of questions please contact our customer service at:

Warning!

Risk of electric shock

- Never try repair an appliance which is defective or presumed to be defective. You may put your own and future users' lives in danger. Only authorised specialists are allowed to carry out this repair work.
- Improper repair will void the warranty and subsequent damages can't be recognized!

Transport

IMPORTANT STEPS WHEN MOVING THE APPLIANCE

- Unplug the appliance and close the water inlet tap.
- Check, if the door and the detergent dispenser are closed properly.
- Remove the water inlet pipe and the outlet hose from the house installations.
- Let the water drain completely from the appliance (see "Maintenance Cleaning the drain pump filter")
- Important: Re-install the 4 transport bolts in the back of the appliance.
- This appliance is heavy. Transport with care. Never hold any protruding part of the machine when lifting. The machine door cannot be used as a handle.

■ Technical Specifications

Power Supply 220-240V~,50Hz

MAX.Current 10A

Standard Water Pressure 0.05MPa~1MPa

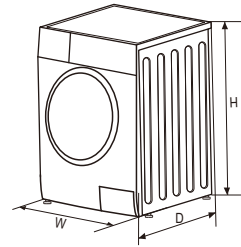

| Model | Washing Capacity | Dimension (W*D*Hmm) | Net Weight | Rated Power |
|---------------|------------------|---------------------|------------|-------------|
| TWD-BM105GF4S | 9.5kg | 595*615*850 | 72kg | 2000W |
| TWD-BM115GF4S | 10.5kg | 595*615*850 | 72kg | 2000W |
| TWD-BM135GF4S | 12.5kg | 595*645*850 | 73kg | 2000W |

MAINTENANCE

Supplier's name or trade mark^(*) (d):

Supplier's address^(*) (d):

Model identifier^(*): TWD-BM105GF4S TWD-BM115GF4S TWD-BM135GF4S

General product parameters:

| Parameter | Value | | Parameter | Value | |
|---|----------------------------|-------|--|-----------------------|-------|
| Rated capacity (kg) | Rated capacity (e) | 7.0 | Dimensions in cm (e) (d) | Height | 85 |
| | Rated washing capacity (b) | 10.0 | | Width | 60 |
| | | | | Depth | 62 |
| Energy Efficiency Index | EEI _w (b) | 51.9 | Energy efficiency class | EEI _w (b) | A (c) |
| | EEI _{WD} (c) | 66.9 | | EEI _{WD} (c) | D (c) |
| Washing efficiency index | I _w (b) | 1.031 | Rinsing effectiveness (g/kg dry textile) | I _R (b) | 5.0 |
| | J _w (c) | 1.031 | | J _R (c) | 5.0 |
| Energy consumption in kWh per kg per cycle, for the washing cycle of the household washer-dryer, using the eco 40-60 programme at a combination of full and partial loads. Actual energy consumption will depend on how the appliance is used | 0.513 | | Energy consumption in kWh per kg per cycle, for the wash and dry cycle of the household washer-dryer at a combination of full and half loads. Actual energy consumption will depend on how the appliance is used | 3.424 | |
| Water consumption in litre per cycle, for the eco 40-60 programme at a combination of full and partial loads. Actual water consumption will depend on how the appliance is used and on the hardness of the water | 48 | | Water consumption in litre per cycle, for the wash and dry cycle of the household washer-dryer at a combination of full and half loads. Actual water consumption will depend on how the appliance is used and on the hardness of the water | 100 | |
| Maximum temperature inside the treated textile (°C) for the washing cycle of the household washer-dryer, using the eco 40-60 programme | Rated washing capacity | 39 | Maximum temperature inside the treated textile (°C) for the washing cycle of the household washer-dryer, using the wash and dry cycle | Rated capacity | 29 |
| | Half | 30 | | Half | 24 |
| | Quarter | 24 | | | |
| Spin speed (rpm) (b) | Rated washing capacity | 1350 | Weighted remaining moisture content (%) (b) | 53.9 | |
| | Half | 1350 | | | |
| | Quarter | 1350 | | | |

MAINTENANCE

| | | | | | |
|---|------------------------|---|---|------------------|--|
| Eco 40-60 programme duration (h:min) | Rated washing capacity | 3:59 | Spin-drying efficiency class ^(b) | B ^(c) | |
| | Half | 3:00 | | | |
| | Quarter | 3:00 | | | |
| Airborne acoustical noise emissions during the spinning phase for the eco 40-60 washing cycle at rated washing capacity (dB(A) re 1 pW) | 76 | wash and dry cycle duration (h:min) | Rated capacity | 9:40 | |
| | | | Half | 7:00 | |
| Type | free-standing | Airborne acoustical noise emission class for the spinning phase for the eco 40-60 programme at rated washing capacity | B ^(c) | | |
| Off-mode (W) (if applicable) | 0.50 | Standby mode (W) (if applicable) | N/A | | |
| Delay start (W) (if applicable) | 4.00 | Networked standby (W) (if applicable) | 2.0 | | |

Minimum duration of the guarantee offered by the supplier ^(a) ^(d):

| | |
|--|----|
| This product has been designed to release silver ions during the washing cycle | NO |
|--|----|

Additional information ^(a) ^(d):

Weblink to the supplier's website, where the information in point 9 of Annex II to Regulation (EU) 2019/2023 is found:

- (a) this item shall not be considered relevant for the purposes of Article 2(6) of Regulation (EU) 2017/1369.
 (b) for the eco 40-60 programme.
 (c) for the wash and dry cycle.
 (d) changes to this item shall not be considered relevant for the purposes of paragraph 4 of Article 4 of Regulation (EU) 2017/1369.
 (e) if the product database automatically generates the definitive content of this cell the supplier shall not enter these data.'

MAINTENANCE

- 1) The actual energy consumption will depend on how the appliance is used.
- 2) The actual water consumption will depend on how the appliance is used and on the hardness of the water.
- 3) Delivery of the spare parts within 15 working days after having received the order.

Product Data Sheet concerning (EU) 2019/2014

The product data sheet for your appliance can be found online.

Go to <https://eprel.ec.europa.eu> and enter the model identifier for your appliance to download the data sheet.

The model identifier for your appliance can be found in the technical specifications section.

Remarks:

- ① The energy efficiency class is from A(highest efficiency) to D (lowest efficiency)
- ② Energy consumption per year, based on 220 standard washing cycles for standard programme at 60°C and 40°C at full and partial load, and the consumption of the low-power modes. Actual energy consumption will depend on how the appliance is used.
- ③ Water consumption per year based on 220 standard washing cycles for standard programme at 60°C and 40°C at full and partial load. Actual water consumption will depend on how the appliance is used.
- ④ Washing performance class from G (least efficient) to A (most efficient).
- ⑤ The standard 60°C programme and the standard 40°C programme are the standard washing programmes. These programmes are suitable to clean normally soiled cotton laundry and they are the most efficient programmes in terms of combined energy and water consumptions for washing that type of cotton laundry. The actual water temperature may differ from the declared cycle temperature.
Please choose the suitable type of detergent for the various washing temperatures to get the best washing performance with less water and energy consumption.

V2.0

16138100006723

MFT100-DU1415BI/T02EPUW-EU(ND)