

TOSHIBA

For household use

Toshiba Electric Rice Cooker/Warmer

Instruction Manual

With cooking menu

Series

RC-10NAF
 RC-18NAF
 RC-10NAFIH
 RC-18NAFIH
 RC-10NAFIM
 RC-18NAFIM
 RC-10NAFE
 RC-18NAFE



Thank you for purchasing Toshiba rice cooker.

- Please read the instruction manual and use it correctly for your own safety.

Before use, please read "Safety Cautions" and "Important Document on Safety Precaution". (page 2 - 3)

- After reading, please keep the instruction manual at a place where any person who is going to use this cooker can find and see it.

Contents

Before Use	Safety Cautions	2
	Important Document on Safety	
	Precaution	3
	How to connect Earth lead wire	4
	Parts Identification	5
Rice Cooking	Basic steps to cook rice	6
	How to cook delicious rice	7
	Rice Cooking Procedures	8
	Standard of cooking amounts and cooking times	8
	Display of cooking times	9
	Setting the timer.....	10
	Clock Adjustment	11
"KEEP WARM" and "REHEAT"	12	
Making Proper Use	Food Menus	13
	Food Preparation Methods	14
	• Bread	15
	• Cake	16
	• Soft-Boiled Egg	17
• How to use "STEAM" with steam stand ...	18	
Clean & Care/Special Notices	Clean & Care	19
	• How to take out and put in the inner lid, steam port	19
	• Cleaning by boiling	19
	In Case of Problems	20
	Power failure	22
	Lithium batteries	22
	Error Indication	23
Specifications	23	

Safety Cautions

⚠ CAUTION

Do not disassemble, repair or modify.

Do not immerse the appliance in water.

Do not attempt to use the metal articles, e.g. a pin or a wire, into the hole.

Do not use when the power supply cord or the power plug is broken, or the power plug is loose.

Do not directly touch the steam with your hand or face.

When disconnecting, hold the power plug and pull it out without touching the power supply cord.

Pull the power plug from the AC outlet when not in use.

Do not place the appliance on the hot, soft, or unstable surface.

Do not use the appliance near fire or water source.

Do not use any other inner pot except the provided one.

Holding the power plug while retracting the power supply cord.

Do not use the appliance in the place which is about 10 cm near the wall, on the paper, clothes, a carpet, or a plastic bag, etc. and the place exposed to direct sunlight.

Wipe away the drops of water and the foreign matter after use.

Do not cover the steam vent with the cloth or place anything while operating.

Do not use the metal spatula, metal-scrubbing brush, nylon-scrubbing brush, and cleanser with the inner pot.

Do not use the appliance near the flammable place or an electromagnetic wave adjuster.

This appliance is not intended for use by young children or infirmed persons unless they have been adequately supervised by a responsible person to ensure they can use the appliance safely.

Do not allow the children to use, keep it out of reach from them.

If the power plug or its polar is dusty, wipe it away with the dry cloth.

Fully fit the power plug into the socket.

Do not open the lid while cooking.

Do not break/scratch, bend, pull, twist, the power supply cord.

Do not place the appliance near the heating source.

Do not put the heavy objects, pinch, or modify the power supply cord.

Do not connect the power supply cord while your hand is wet.

Right after use or while using, do not touch the hot part (e.g. the inner part of the outer lid, a heating plate, a steam vent, or the inner pot)

Do not use the appliance near the wall or the furniture.

Do not touch the hook button while moving the appliance.

Do not move the appliance while cooking.

Do not warm rice with the spatula inside inner pot.

Do not cooking if the inner pot is not inside the appliance.

Unplug the power cord before cleaning the appliance.

This appliance is not intended for use by persons (including children) with reduced physical, sensory or mental capabilities, or lack of experience and knowledge, unless they have been given supervision or instruction concerning use of the appliance by a person responsible for their safety.

Children should be supervised to ensure that they do not play with the appliance.

This appliance is intended to be used in household and similar applications such as:

- staff kitchen areas in shops, offices and other working environments;
- farm houses;
- by clients in hotels, motels and other residential type environment;
- bed and breakfast type environment.

If the power supply cord is damaged, it must be replaced by the manufacturer, its service agent or similarly qualified persons in order to avoid a hazard.

The boiling water may overflow from adjusting the amount of water exceed maximum water level scale for cooking.

A warning of potential injury from misuse.





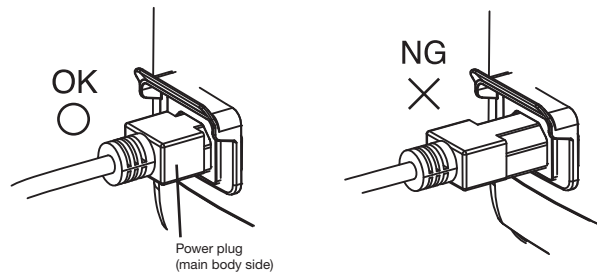



A warning to avoid spillage on the connector.

Insert the power plug (main body side) into the plug insertion hole on the rear side of the main body.



⚠ Insert the power plug into the hole completely.

Important Document on Safety Precaution

	 Indicates the forbidden operation.
	 Indicates the information which should be followed strictly.
<h2>Safety Warning</h2>	
 <p>Forbidden</p>	<p>Do not disassemble, repair, fix, or modify the product (unless indicated in the operation manual). Do not pull or insert the electric plug and the magnetic plug with wet hands. Do not touch the product, cable, or electric plug with wet hands. Do not operate the product if the cable or electric plug is damage, or the electric plug is inserted improperly. Do not modify or repair the cable and electric plug or use other cables which are not included with the product (except the ground wire). Do not bend, break, twist, or pull the cable while the product is operating. Do not place the product or other objects on the cable or pinch the electric plug or the cable. Do not place the electric plug or cable in the place with high temperature, flooded water, and high humidity or touch it with sharp-edge object. Do not connect the product to the power source which is not specified in the operation manual. Do not expose the product to water. Do not use the adaptor plug in order to fit in the power outlet. Do not use the power outlet together with other electric appliances.</p>
<h2>Safety Caution</h2>	
	<p>Insert the electric plug into the power outlet as far as the base of the electric plug. To unplug, hold the body of the electric plug and pull it off. Wipe dust or moisture at the electric plug's pins thoroughly before inserting it into the power outlet. Pull the electric plug out of the power outlet when the product is not in use. Pull the electric plug out of the power outlet before maintaining or cleaning the product.</p>
<h2>Caution for Safety Installation</h2>	
	<p>Do not bring any flammable object, hazardous object, chemicals, or flammable gas near or in the product. Do not install the product near the naked flame, wet area, or hot and high humidity area. Do not install the product in the high electromagnetic area. Do not install the product in the area within a child's reach. Do not install the product on the slant or insecure floor. Connect the ground wire at the specified position on the product.</p>
<h2>Caution for Safety Operation</h2>	
	<p>Read the operation manual carefully and thoroughly before using the product. Always inspect that the product is in a good operating condition before using by following the recommendation in the instruction manual. Remove all packing materials. Do not allow children to use the product alone. Do not place any object on the product or cover the product while in use (unless indicated in the operation manual). Do not touch any hot or cold parts of the product. Do not use "Max" water level scale for cook rice. It may cause burn injury.</p> 

How to connect Earth lead wire

(Model RC-10NAF and RC-18NAF)

1. Remove Screw, Spring washer and Flat washer on Earth connecting plate.

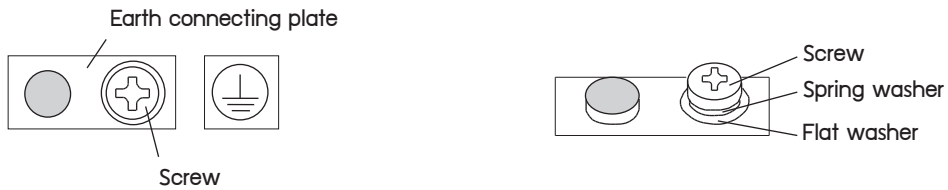

2. Set Earth lead wire on Earth connecting plate then put Flat washer and Spring washer respectively on Earth lead wire. Then tighten Screw firmly.

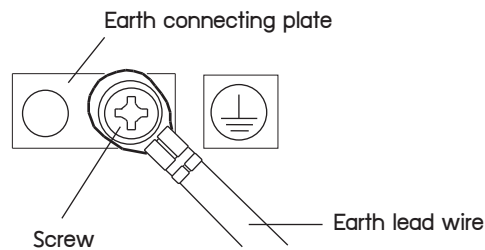

Parts Identification

Body

- When using for the first time, please wash the inner pot, inner lid, steam port, other accessories and attachments (page 19).
- At first use, there might be an odor from plastic, etc. This odor will disappear after using (page 22).

Inner Lid
Every time, remove and wash.
To prevent forgetting to attach the inner lid, if the inner lid has not been attached, the outer lid cannot be fitted to close.

Inner pot
To prevent scratches, there is the protection paper between the inner pot and the heater. Remove it before using.

Hook Button

Operation Panel

Air Vent (at the bottom)

Temperature Sensor
(remove foreign matters)

Steam Port
(remove and wash every time)

Outer Lid

Steam Exit

Inner Lid Packing

Handle

Model name

Rated value indicating part (at the back)
Indicating precautions to ensure safe use of the cooker.

Power cord (Cord set)

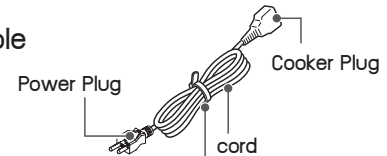

Please remove strap from cord when using rice cooker.

Cooking Heater

Cooker Plug Hole

Safety Warning Label

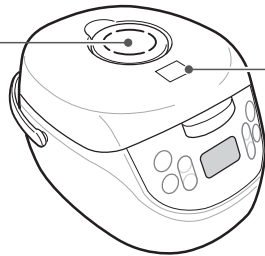

Accessories

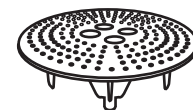

Operation Panel

"Mixed rice" Key

"Off/Cancel" Key

"Keep Warm/ Reheat" Lamp

"Keep Warm/ Reheat" Key

"Menu" Key

Select by pressing the "Menu" key.

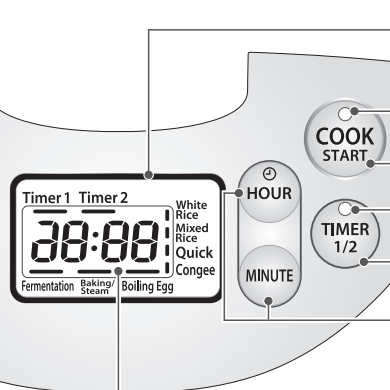

Display Panel

Shows all indications about cooker conditions with 24 hour displaying clock.

"Cook/Start" Lamp

"Cook/Start" Key

"Pre-programmed" Lamp

"Pre-programmed" Key

"Hour/Minute" key (Time setting)

Basic Steps to Cook Rice

Preparation

Basic Steps

1 Measure rice with the measuring cup provided.

A level cup = 180ml

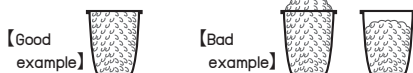

- It might differ from other food measuring cups (200ml) or other rice measuring vessels.

2 Wash rice.

Quickly rinse the rice until the water runs clear.

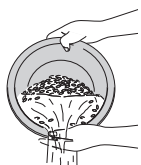

The inner pot can be used to rinse rice

- ① Fill plenty of water, swirl the rice around quickly and gently (with one hand), then pour out the water immediately.
 - ② Polish the grains of rice and rinse several times, until the water runs clear.
- In case of washing rice in the inner pot, please do not use any whisk.

3 Adjust the water level. Select the water level scale based on the size and number of the measuring cup.

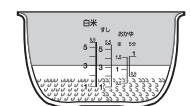

In case of cooking white rice, select "White Rice" (Water level scales for other kind of rice...page 8)

Level off the rice, on a flat place.

- Please adjust the water level according to your taste.

4 Wipe off water droplets, foreign substances, and set the inner pot, then close the lid.

If there are water droplets or foreign substances left or stuck to the following parts, please wipe off.



- water droplets or foreign substances left may cause steam leakage, cause the lid to fail to close completely, and cause the rice not to cook well.

Levelly place the inner pot on the bottommost part inside the cooker (without inclination to either side).

Turn the inner pot 2-3 times in the direction as shown by the arrows, to have it closely touch the cooking heater.

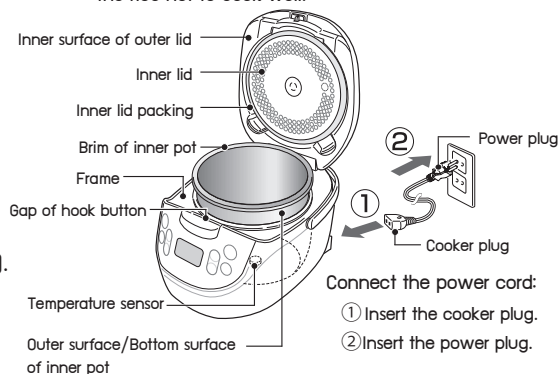

5 Set up the cooking menu, make sure, and start cooking.



Press the "COOK" key.

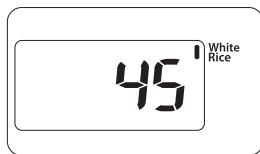

Indicating the time until cooking finished at intervals of every 5 minutes.

- There's no need to soak the rice. (It will be done automatically after pressing the "COOK" key.)
- Please do not forget to close the lid and attach the steam port.

If the buzzer sounds, it indicates that the rice has cooked.

"Keep Warm" lamp lights up.

▶ After using, press the "OFF" key and unplug from power outlet.

❗ Please press the "OFF" key to cut off power before removing the inner pot.

※ During keeping the rice warm, although removing the inner pot, the cooker will not turn off automatically.

6 In the case of "cooking immediately after keeping warm" or "continuously cooking" please wait until the temperature of the inner lid, the temperature inside the cooker, etc., have cooled down to the room temperature.

How to cook delicious rice



Measure rice accurately (level off the top).



Do not shake the measuring cup

If shaking, the amount of rice will increase more than enough.

Measuring cup provided with the cooker

Do not wash rice with hot water. Do not wash rice for a long time.

Washing with hot water or washing slowly may cause a bad odor of rice bran.

Gently wash, to avoid smashing the rice grains.

Lightly rub the rice grains one another. (Cracked or broken rice tends to get mushy and sticky when cooked.)

Adjust water level according to preference.

If preferring harder rice	lower the water level below the indicated scale
If preferring softer rice	raise the water level above the indicated scale
Freshly-harvested rice	slightly below the indicated scale
Brown rice	according to the indicated scale
Old Rice Rice during rainy season to summer Wheat	slightly over the indicated scale

The condition and quality of each kind of rice is different, depending on brands, places of origin, storage conditions. Therefore please adjust according to your preference.

When cooking is finished, loosen the cooked rice entirely with a scoop.

Please loosen the cooked rice by holding the inner pot with a dry cloth or mittens to prevent it from clumping or sticking together.



"Keep warm" operation should end in a short period of time.

In the case of "rice seasoned and cooked with various ingredients", small amount of rice, or keeping warm for extended periods, it is advised to wrap in plastic wraps and keep in the freezer. (page 12)

About Rice

- Buy a proper amount of new rice of which the rice-polishing date indicates that it can be completely consumed within 2 weeks - 1 month.
- Prevent oxidation by keeping rice in a tightly closed container and store it in a dark, cool place.

After washing, do not leave the rice in a colander.

Avoid leaving the rice in a colander.



The rice grains may get cracked resulting in becoming mushy and sticky when cooked.

Unsuitable kinds of water for rice cooking

Hard mineral water



Ionized water over pH9

(A cause of hard and dry rice) (A cause of mushy and sticky rice)

Rice cooking water should be 30°C or lower.

It is recommend to use cold water for pre-programmed cooking in summer.

(Too-high water temperature will result in undelicious cooked rice and unpleasant odor.)

In summer, use cold water



After using, immediately clean and care.

Wash and keep the inner lid, inner pot, steam port clean all the time.

After washing, wipe off water droplets with a clean cloth.

(Leaving the cooker dirty will cause bad smells.)

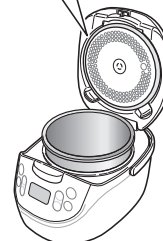





After stop "Keep Warm" operation, do not leave rice in the pot (it will cause unpleasant odors).

(Regarding "Clean & Care, please see page 19)

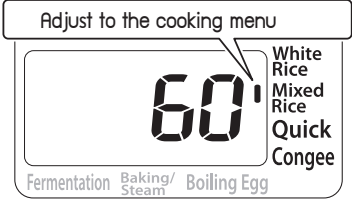
Rice Cooking Procedures

Operation Method

Operation	<p>1 Select the cooking menu with </p> <div style="border: 1px solid black; padding: 5px; width: fit-content; margin: 10px auto;"> Adjust to the cooking menu  </div>	<ul style="list-style-type: none"> ● Every time we press the “MENU” key, “” mark will move and the selection will consequently change.
	<p>2 Cooking starts, after pressing </p>	<ul style="list-style-type: none"> ● [“Cook” lamp] lights up. ● Showing a rough indication of remaining time until cooking is finished.
Rice Cooked	<p>When rice is cooked, the buzzer sounds to show cooking is finished. Keeping warm automatically</p> <div style="border: 1px solid black; padding: 5px; width: fit-content; margin: 10px auto;"> <p>TIPS Immediately loosen cooked rice</p> <ul style="list-style-type: none"> ● Please do not keep the rice warm for longer than 12 hours. </div>	<ul style="list-style-type: none"> ● [“Keep Warm” lamp] turns on. Showing the elapsed time for keeping rice warm in units of an hour. [ : hour(s)] ● Please do not use “Keep Warm” settings for any type of rice other than white rice, such as porridge, rice seasoned and cooked with various ingredients.
<p>After using Press “OFF” key and pull the power plug from the outlet.</p>		

Select the “Water level scale” and the “Rice Cooking menu” that match the type of rice to be cooked.

Type of rice to be cooked	Cooking menu	Water level scale	cooking amounts of rice unit : cup		Standard times for cooking unit : minute	
			1.0 L type	1.8 L type	1.0 L type	1.8 L type
White rice	White Rice	White Rice	1-5.5	2-10	35~47 min.	38~49 min.
White rice (Rapid cook)	Quick	White Rice	1-5.5	2-10	44~47 min.	32~35 min.
Mixed rice	Mixed Rice	Mixed Rice	1-5.5	2-10	57~68 min.	59~72 min.
Glutinous rice	White Rice	Glutinous Rice	1-3	2-5	34~38 min.	33~39 min.
Porridge	Congee	Porridge	0.5-1.5	1-3	62~68 min.	62~69 min.
Congee	Congee	Congee	0.5-1	0.5-1.5	61~69 min.	62~65 min.

- Actual cooking time may vary by about 10 minutes, depending on amounts of rice, amounts of water, water temperatures, etc.
- “Max” water level scale for boil water only. Please do not fill water over this level scale.

White Rice...

- Makes rice particularly tasty. The cooker spends time to ensure deliciousness.

Quick (fast rice-cooking)... for cooking white rice.

- Since priority is given to the cooking time, the rice may become too hard or mushy. If feeling worried, please loosen rice entirely in the inner pot after cooking is finished immediately and sprinkle a little water on the top surface of cooked rice. Then cook it again by <STEAM> menu.
- Do not use "Quick" feature for the following types of rice.
Do not use for mixed rice, congee, any type of rice other than white rice.

Rice seasoned and cooked with various ingredients...

➡ [Please see the cooking method of "five ingredient rice" on page 13]

- For cooking tips, please see "When putting in the materials or adding seasonings" (page 13)
- For cooking with sticky rice solely may result in getting too soft, depending on amount of water for cooking.

Mixed Rice (Germed Brown Rice)...

- Please cook with the <Mixed Rice> menu.
- It is recommended to mix germed brown rice with white rice in ratio of 1 to 2 to prevent the cooked rice is too hard.
(1 cup of germed brown rice to 2 cups of white rice) Germed brown rice can be cooked solely.

When desiring to mix rice with cereals...

- Please cook in the <Mixed Rice> menu. Please also read the cereal cooking instructions.
- After cooking cereals, the steam port will be particularly easy to become dirty. Please do not fail to wash the inside of steam port.

In case of desiring to mix cereals that float in water, please soak them in water for 2-3 hours, until they have already sunk before cooking. Cooking amounts should not be too large. [not more than 3 cups (1.0L type) or not more than 5 cups (1.8L type)] (Because it may cause mixed rice with cereals cannot be well cooked.)

Congee, Porridge...

- ❗ Please cook by the <Congee> menu. (Cooking by any other menu will cause spillage, burn wounds.)
- Please use white rice. In this case, brown rice cannot be well cooked.
- Seasonings (such as salt, etc.) should be added after cooked. (It may be not well cooked if adding seasonings from the beginning.)
- Boiling over from rice cooking may exit from the steam port, depending on rice quality, water temperature, washing methods.

Please follow the instructions

- To prevent "Spilling over", "cooking failure" problems, please follow the setting instructions.
- Do not use pre-programmed settings when adding ingredients, or when cooking any kinds of rice seasoned. (They are the causes of cooking failure, decay.)

Notice

- As it is a rice-cooking heater style, the cooked rice at bottom part may be rather soft. So please loosen rice entirely in the inner pot after cooking is finished or the rice on the bottom of inner pot may turn golden brown, depending on amount of water.

Rice-cooking time indication. (Indicates the remaining time)

The display shows the remaining cooking time, such as...

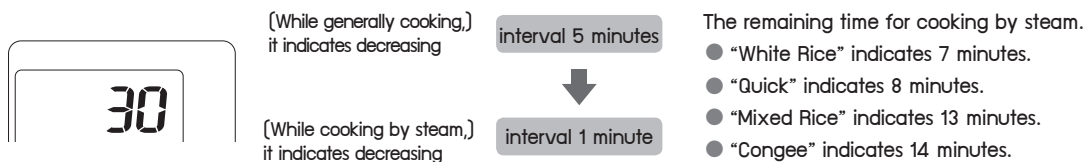







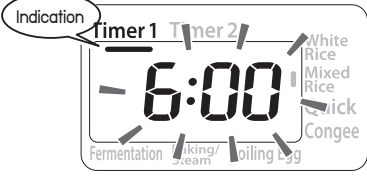

Setting the timer

Cooking at the preset time.

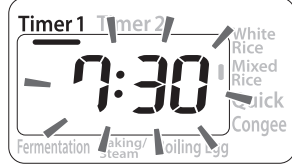
2 ways of preset cooking times can be memorized, so we can use it separately with a proper selection.

[For example : one is for breakfast, and another one is for dinner.] Please do not use pre-programmed settings for rice seasoned and cooked with various ingredients.

Preparation	<p>Check whether the current time is correct or not.</p> <hr/> <p>Put the inner pot in the cooker and close the lid.</p>	<ul style="list-style-type: none"> If the current time is incorrect, it will not be well cooked at the pre-programmed time.
Operation	<p>1 With  set the cooking menu, adjusting to make it proper for the kind of rice to be cooked</p> <hr/> <p>2 Press  </p>	<ul style="list-style-type: none"> Please set the "MENU" key to the "Congee" menu when you make porridge or congee. Cooking porridge with any other menus may cause boiling over/burn wounds. Every time we press the "TIMER" key, the display will change between (Timer 1) and (Timer 2).
	<p>3 Set the completion time with   </p> <div style="border: 1px solid black; padding: 5px; width: fit-content;"> <p>24 hours clock displays Morning7:00 Night19:00</p> </div> <p style="text-align: center;">【example : The rice cooks at morning : 7:30】</p>	<ul style="list-style-type: none"> The completion time can be set in units of 10 minutes with "MINUTE" key. If we keep pressing "HOUR" key for a while, the time display will change hour indicator quickly. Because the pre-programmed times are memorized, In the case of the cooking in the same condition, a new timer setting is not necessary.
	<p>4 Press  Pre-programmed cooking is completed</p> <div style="display: flex; justify-content: space-around; align-items: center;"> <div style="text-align: center;">  <p>The light turns on</p> </div> <div style="text-align: center;">  <p>The light turns off</p> </div> </div> <p style="text-align: center;">➔ The rice cooks at the pre-programmed time.</p>	<ul style="list-style-type: none"> Pre-programmed time will be displayed until rice-cooking starts. When rice-cooking starts, the "Cook" lamp will light up. The remaining time until the rice has cooked will be displayed. If the "Cook" key is not pressed, it will sound 「♪ Beep-Beep-Beep-Beep」 (to show that pre-programmed settings are still not completed).

When desiring to cancel the pre-programmed settings or if the operation is incorrect

Press 

Possible pre-programmed menus

- Please do not use pre-programmed function to each of the following items marked with "X".

white rice	porridge	brown rice	cereals	rice seasoned and cooked with various ingredients
○	○	○	○	×

Pre-programmed Time

- Please should not set pre-programmed times for so long as 14 hours or more. (maximum 8 hours in summer). Too long pre-programmed times will may cause decay and unpleasant odors.
- If the pre-programmed time is less than standard times for cooking (page 8), the cooker will start cooking immediately.

During Pre-programmed operation, if desiring to see the current time, we can press the key 

- The current time will be displayed only while the "HOUR" key is pressed.

How to make proper use of [TIMER 1] and [TIMER 2]

- 2 ways of pre-programmed time can be memorized

Example	for breakfast ...	[TIMER 1]	6:30
	for dinner ...	[TIMER 2]	19:30

By pressing  [TIMER 1] ⇄ [TIMER 2].



We can save time by pressing the  key to change between [TIMER 1] ⇄ [TIMER 2].

Notice

- If the cooked rice is quite soft, please reduce the amount of water according to your preference.
- In case of pre-programmed cooking, starchy substances will sink to the bottom and may become light brown.
- In case of low room temperatures and low water temperatures, rice may cook later by about 10 minutes.

Clock Adjustment

The clock will display 24 hours of time. (midnight ...0:00 / midday...12:00)

- Insert the power plug and keep pressing  for at least 1 second.
 - During cooking, keeping warm, pre-programmed operation, the clock cannot be adjusted.
- Adjust the time with  

If we keep pressing "HOUR" key, the time display will change quickly in units of an hour.
If we keep pressing "MINUTE" key, the time will change in units of 10 minutes.
- If pressing , it means "completed"
The display will stop blinking.

“KEEP WARM” and “REHEAT”

After cooking, the rice will automatically be kept warm.

- “Keep Warm” temperature can be controlled automatically depending on using conditions, in order to keep our rice warm and delicious.
- Press the “OFF” key, when desiring to stop “Keep Warm” operation.
- During keeping rice warm, although the inner pot is removed, power will not be cut off automatically.

■ Do not use the “Keep Warm” feature in the following cases:

[They are causes of bad odors, decoloration]

- using for longer than 12 hours.
- using for any rice seasoned and cooked with various ingredients.
- using while there is a scoop, etc. in the pot.
- using for cold rice.

■ Do not stop “Keep Warm” operation, while the rice is still in the inner pot. (It may cause a bad smell)

※ If the rice has an unpleasant odor, please see the instruction on page 20.

If the display blinks during “Keep Warm” operation, please press the “OFF” key, and take the rice out.



In the “Keep Warm” mode, when the display starts blinking after the elapse of 13 hours, please press the “OFF” key to turn off the (“Keep Warm”) mode.

Tips for keeping rice warm

- Gathering rice to central part will help it not to get too hard, too mushy and sticky.
- During keeping rice warm, if worrying that it may get too mushy and sticky, please do not let the rice left at the side of inner pot.

During keeping rice warm, if desiring to see the current time,

please press .

- The current time will be displayed only while the key is pressed.

When desiring to keep rice warm after cutting power

Operation

If pressing  it will start to keep the rice warm.



- “Keep Warm” lamp will light up.

When desiring to stop keeping rice warm

Operation

If pressing 



Before taking out the inner pot, please press the “OFF” key and unplug to cut off power.

- “Keep Warm” lamp turns off.
- ※ During keeping rice warm, when the inner pot is removed, power will not be cut off automatically.

When desiring to reheat rice during the <KEEP WARM> function

Operation

During keeping rice warm, loosen it and close the lid.

If Pressing , Reheating will start. (Display indicates 9 mins.)

➔ The buzzer sounds to show completion. (Goes back to “Keep Warm” operation.)

- During reheating, “Keep Warm” lamp blinks, and the display indicates the remaining time.

《When desiring to stop reheating halfway》

If pressing the “Keep Warm” key, it will go back to “Keep Warm” operation.

- Do not reheat in the following cases:
 - Reheating more than once. (It is a cause to make rice getting dried and yellowish)
 - Reheating cold rice. (It is a cause of unpleasant odors)
- If the amount of rice is too large, it may not get warm perfectly. (The standard is a half of inner pot or less)

Food Menus

- For rice measuring, please use the measuring cup provided. (1 cup = approximately 180 ml.)
- 1 tablespoon = 15 ml. 1 teaspoon = 5 ml.

Five-ingredient rice

(Maximum amount)
4 cups or less (type 1.0L)
6 cups or less (type 1.8L)

Ingredients (for 4 persons)

Rice	3 cups
Carrots	60 g
Boiled bamboo shoots	60 g
Dried mushrooms	2 pieces
Chicken breasts	60 g
Deep-fried tofu 20g (about 1/2 pc.)	
A { Sake	1 tablespoon
Salt	1 teaspoon
soy sauce	1 tablespoon
Instant bouillon	
.....	1/2 teaspoon
Shitake mushrooms soaking liquid	

- 1 Wash and rinse the rice quickly until the water runs clear, and soak in plenty of water for 30 minutes.
- 2 Soak dried mushrooms in water and cut into stripes. Pour water over deep-fried tofu before cutting into stripes. Also cut carrots into stripes. Cut boiled bamboo shoots into thin slices, cut chicken breast into small pieces.
- 3 Drain the rice in a colander and put it in the inner pot. Add ingredients "A", and pour mushrooms soaking liquid until it reaches the water level scale 3 of "Mixed Rice". Then, mix all the ingredients together.

- 4 Place the fine-cut ingredients on top of the rice in a ring shape and close the lid.



- 5 Select the <Mixed Rice> menu by "MENU" key, and press "COOK" key.
- 6 When becoming "Keep Warm" mode, loosen it gently and entirely.

"KEEP WARM" and "REHEAT"

Food Menus

When putting ingredients or adding seasonings

Keys to good cooking of mixed rice

- Soak in plenty of water for 30 minutes.
 - After soaking rice, drain it in a colander to strain the rice.
 - [Do not leave in the colander after draining]
Adjust the water level after adding seasonings, mix it well from the bottom.
 - Start cooking immediately.
 - Regarding ingredients...Cut them into small pieces. Do not mix them with the rice
...Place them on top of the rice in a ring shape
...The ingredient proportion to 1 cup of rice is 70 grams or less (In case of dried beans : 30 grams or less)
- Do not put in vegetables from the beginning. Put boiled vegetables after the rice has been cooked. (It will cause steam port to be blocked or boiling over.)

- Do not cook by [Quick] menu
- Do not cook by "Keep Warm" feature./"pre-programmed" feature. (It will cause rice decoloration/decay, inner-potter corrosion.)
- It may not be well cooked, in case of using a mixture of ingredients prepared according to a recipe in general markets, or using anything other than water. (e.g., juices, etc.)





Food Preparation Methods

⚠ WARNING

Please do not cook or use any ingredients which are not mentioned in page 15 – page 18 because they may cause steam or ingredients to spill over or scatter, resulting in burn wounds, injuries, damages, etc. Besides, they may be causes of inner pot corrosion, bad odors, etc.

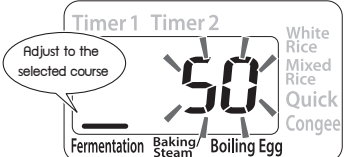
Basic procedures

Procedures in details page 15–18

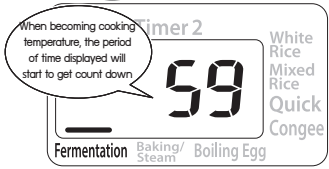
Operation	<p>1 Select menu by </p> 	<ul style="list-style-type: none"> ● Every time the “MENU” key is pressed,  will move, and the selection will consequently change. <div style="border: 1px solid black; padding: 5px; margin-top: 10px;"> <p>It is a cooking menu that keeps temperature constant.</p> <p><Fermentation> about 35°C</p> <p><Baking/Steam> about 115°C</p> <p><Boiling Egg> about 70°C</p> </div>
	<p>2 Adjust time by </p>  <p>【Ex. Cooking time 60 minutes】</p>	<ul style="list-style-type: none"> ● It can be set to the maximum of 60 minutes with 1 minute/unit. ● If keep pressing the key, times displayed will change in units of 10 minutes.
	<p>3 Start cooking by </p> 	<ul style="list-style-type: none"> ● [The “Cook” lamp] lights up. ● The real cooking time will be longer than the set time, because the cooker needs times to preheat the cooking temperature.
Completion	<p>When cooking is finished, the buzzer sounds. Automatically cut off power</p> <ul style="list-style-type: none"> ● Please be careful to take the inner pot out, because it is very hot. ● Do not leave any food in the inner pot for a long time. 	<ul style="list-style-type: none"> ● It is easy to smell bad, so please always clean with good care. Please clean by boiling whenever worrying about any bad odor. (page 19)

Notes

- Pre-Programmed feature cannot be used for food menus.
- “Food preparation” times mentioned in page 15 – 18 are for reference only. The actual time results may vary depending on ingredients, room temperature, etc.
- Please use plastic or wooden cooking utensils, to prevent the inner pot from getting scratched.
- Make sure the inner pot has been put properly in the cooker. If it does not closely touch the cooking heater, the food may not be well made. (page 6)

Simple Round Bread

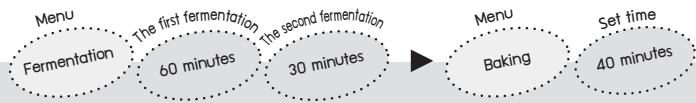

Ingredients

A	Bread flour.....	100 g
	Dried yeast	2 g
	Sugar	5 g
	Salt	2 g
Milk	60 ml	
Butter	10 g	



How to cook

1 Put the ingredients (A) into a bowl.

2 Heat milk, add butter and melt it. Then, cool it down at 40°C. Mix it and the ingredients (A) together by a whisk until clumping. Put mixed ingredients on a table and knead it by hand until its texture becomes smooth.



3 Make the dough to a round shape and put in the inner pot which has been applied lightly with a little vegetable oil (to be easier fermentation when the dough is well heated). Turn the edge of rolled seam to the bottom side and lightly press the rounded dough to get a little flatter. Then close the lid.



4 «The first fermentation»
Select <Fermentation> with "MENU" key. Set the cooking time to 60 minutes with "MINUTE" key. Then press "COOK" key.



5 After the first fermentation is completed, open the lid and rest the dough to be swollen about 2 minutes. The dough will expand about 2 times bigger.

6 Pierce to the center of the dough with your fists to degas from the dough.



7 Take the dough out of the inner pot. Make it to a round shape and put in the inner pot (lightly applied with a few vegetable oil.) by turning the edge of rolled seam to the bottom side. Press the rounded dough to get a little flatter. Then close the lid.

8 «The second fermentation»
Select <Fermentation> with "MENU" key. Set the cooking time to 30 minutes with "MINUTE" key. Then press "COOK" key.

9 After the second fermentation is completed, open the lid. «Check the fermentation condition.»
Press the dough by a finger.

- If the hole rise a little, it indicates that fermentation has completed.
- If the hole rise to the previous state, it indicates that fermentation has not been enough.
Please increase cooking times of fermentation for next time.
- If the hole does not rise, it indicates that fermentation has been excessive.
Please decrease cooking times of fermentation for next time.

10 «Baking»
Remove the steam port to prevent liquid dripping. Select <Baking/Steam> with "MENU" key. Set the cooking time to 40 minutes with "MINUTE" key. Then press "COOK" key.

11 After baking is finished, take the bread out of inner pot with a scoop.
※ If desiring to get the top surface browned, please turn over the bread and bake additional 10 minutes.

Cooking Memo

- Bread may not rise well, if the dough has not been kneaded enough and the fermentation time are too short.
- After cooking is finished, if the bread still left in the inner pot. The top surface of the bread may become sticky.

Butter Cake

Menu
Baking
Set time
40 minutes

Ingredients

A	Butter cake mix flour.....	400 g
	Egg.....	6 eggs
	Milk.....	60 ml
	Butter.....	220 g



How to cook

1 Put the ingredients (A) into a bowl.

2 Beat the ingredients (A) together by a whisk firmly.



3 Add milk and melted butter to the mixed ingredients (A). Mixing all the ingredients, quickly and entirely (to prevent air bubbles).



4 Gradually pour the mixed butter cake flour about 200 ml to the inner pot which has been applied lightly with a little vegetable oil (to be easier baking when mixed butter cake flour is well heated). Then close the lid.

5 «Baking»
Remove the steam port to prevent liquid dripping.
Select (Baking/Steam) with “MENU” key.
Set the cooking time to 40 minutes with “MINUTE” key.
Then press “COOK” key.

6 After baking is finished, take the butter cake out of inner pot with a scoop.
※ If butter cake texture is not well cooked, please increase the cooking times of baking.

Cooking Memo

- Fresh cream, fruits, etc., can be applied as toppings.

Soft-Boiled Egg

Ingredients

- Egg..... 2-6 eggs
- Water 500 ml

Menu
Boiling
Egg

Set time
25 minutes



How to cook

1 Put eggs into the inner pot and fill in the water about 500 ml. Then close the lid.

2 «Boiling egg»
Select [Boiling egg] with "MENU" key.
Set the cooking time to 25 minutes with "MINUTE" key.
Then press "COOK" key.

3 After boiling is finished, take boiled eggs out of the inner pot immediately with a ladle. Peel off egg shells gently. Then put them in a bowl and pour with your favorite sauces.

- ※ If boiled eggs are rather soft, please increase the cooking times of boiling.
- ※ If boiled eggs are rather hard, please decrease the cooking times of boiling.

Cooking Memo

- The condition of boiled eggs may vary depending on egg sizes, amount of water, etc.
- Soaking boiled eggs in hot water for a long time, boiled eggs will be rather hard.



How to use “STEAM” with steam stand

How to pour water

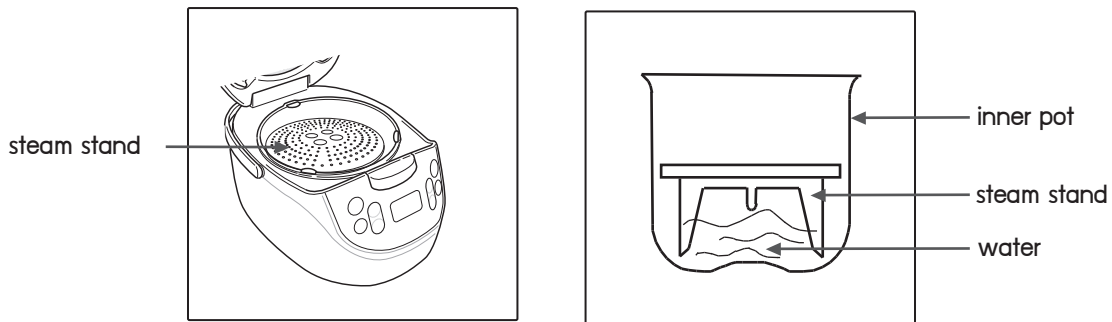

Rice cooker	Water level	
	Minimum	Maximum
1.0L type	450 ml. (approximately 2.5 cups of measuring cup)	800 ml. (approximately 4.5 cups of measuring cup)
1.8L type	600 ml. (approximately 3 cups of measuring cup)	900 ml. (approximately 5 cups of measuring cup)

How to use “STEAM” menu

Follow “Food Preparation Methods” (steps 1 to 3) on page 14 by selecting [Baking/Steam] menu.

- If desire to cancel steaming function before operation is finished, press  once.
- Please be careful and make sure that the water is filled into the inner pot with the proper amount following the above table before starting operation.

Clean & Care

Using an unclean cooker will result in bad odors, etc. Therefore, please keep it clean all the time. Always make sure to wipe off the water droplets from the steam port, inner pot/packing.

CAUTION

Unplug the cooker before cleaning and caring. (It is a cause of burn wounds)

Please do not use the following materials

(They are causes of deformation, discoloration, corrosion, cracks, scratches)

- dish washers/dish dryers
- detergents other than neutral detergent for kitchen use
- benzene, thinner, alcohol, cleanser, bleaching agent
- Scrubbing brushes, Melamine Sponges which easily cause scratches

The inner lid is made from aluminum. It may be decolorized by detergents used for dish washers.

The inner pot, the inner lid, the steam port, and scoop should be washed after each use.

The measuring cup should be washed with neutral dishwashing detergent. Adding seasonings in the inner pot without washing the inner lid after that, will result in bad odors.

Do not wet the cooker body, cooking heater, temperature sensor.

Wipe off dirt and foreign substances with a well-wrung cloth.

- Do not wash without taking it apart (Steam port, Inner lid). Do not wet the operation parts and outer lid (cover lid). Do not pour water into the inner side of the cooker body.
- Do not pull the steam packing forcefully. (It does not come off)

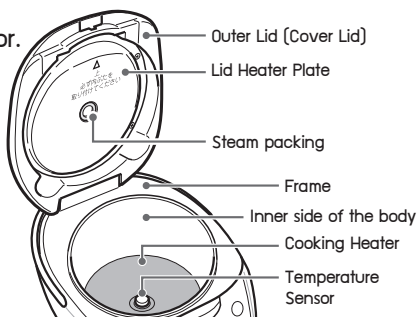

Use cotton buds to remove dirt, foreign substances from the air vent (at bottom of cooker body) and hook button gap.

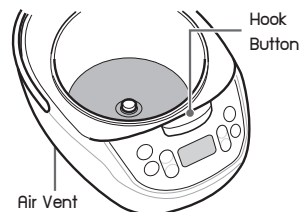

If there are any grains of cooked rice left at the cooking heater/temperature sensor, please rub gently with soft-sandpaper (approximately no. 600), and wipe off with a well-wrung cloth.

Steam port

Each time of use

Remove by

pulling up to the top direction



Set the brim

to the hollow part and push down until it clicks



Open

Close

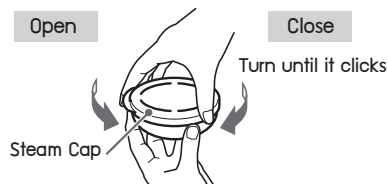

Inner Lid

Each time of use

Remove by

pulling forward

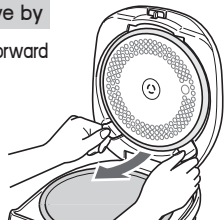

Attach

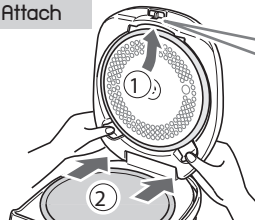

Outer lid hole

Inner lid convex part

- ① Insert the convex part of inner lid into the hole of outer lid.
- ② Press to make it fully attached.

- Without attaching the inner lid, the outer lid (cover lid) cannot be closed completely (to prevent forgetting to attach the inner lid).

Cleaning by boiling (approximately once a week) Please also do whenever it smells unpleasant.

- 1 Put water in the inner pot (until it reaches the water level scale 1 for white rice), and close the lid.
- 2 Select <WHITE RICE> with "MENU" key, and Press "COOK" key.
- 3 When it becomes "Keep Warm operation", press "OFF" key. When the cooker has cooled down, remove the inner lid, inner pot and steam port to wash and dry them.

- Do not put anything (e.g., detergents, etc.) other than water.
- Do not consecutively clean by steam.
- Some smell may not be completely absent.

In Case of Problems

Before making repair requests, please investigate once more. If cannot investigate or take further action by yourself, please make an inquiry to Toshiba service center.

Trouble Cases		Causes/points of investigation	(Reference Page)
The cooker doesn't power on. The rice does not cook. The cooked rice is tepid although being handled with "Keep Warm" function. The rice is juicy. Key operation cannot be performed.		<ul style="list-style-type: none"> ● Is the cooker unplugged or does the plug fall out of the outlet? ● If the current time is displayed during the cooking or the "Keep Warm" operation, the cooker is in a power failure state and the plug is disconnected or the circuit breaker shuts down power. 	
Rice	Soft Mushy, Sticky Clumping together Undelicious	<ul style="list-style-type: none"> ● Please cook the rice with less water. ● When the rice has cooked, loosen it immediately and entirely. ● Please cook new rice with less water. ● Soaking beforehand will soften the texture of rice cooked with pre-programmed settings. ● Washing the rice grains forcefully or leaving it in a colander may cause it to get cracked and become mushy, sticky when cooked. ● Is it cooked with hot water or alkaline ionized water with pH 9 or higher? 	
	Hard Dry Undelicious	<ul style="list-style-type: none"> ● Please cook the rice with more water. ● Please soak the rice grains before cooking. ● Was it cooked with mineral water which has high degree of hardness? 	
	Getting scorched ※ Getting a little burnt and turning to light brown is not a result of breakdown or failure	Rice gets scorched easily in the following cases: <ul style="list-style-type: none"> ● When rice has not been washed enough. ● When soaking time is too long. ● When there are dirt or foreign substances stuck to the temperature sensor. ● When adding seasonings to rice cooked with several ingredients. When cooking germed brown rice, etc. 	
	Undelicious, Not cooked well	<ul style="list-style-type: none"> ● Do you cook rice while the cooker inner side, inner lid, etc. are still hot or warm? Please wait until their temperatures have cooled down to the same level of room temperatures. ● In case of "QUICK" operation, the rice may be rather hard, or rather soft. (pages 6, 9) ● Are there any foreign substances stuck to the temperature sensor, inner lid packing, steam port, etc.? (page 19) ● Is the inner pot deformed? Did you forget to attach the inner lid, steam port, etc.? ● Was there any power failure? Was the cooker unplugged? 	
	Rice seasoned and cooked with various ingredients is not cooked well.	<ul style="list-style-type: none"> ● Are there any ingredients mixed with the rice? ● In other cases, please see page 13 "When putting ingredients or seasonings". 	
Kept warm Rice	Unpleasant odors ※ In case of having unpleasant odors, please clean by boiling and get it dried before the next use. (Page 19)	<ul style="list-style-type: none"> ● Has "Keep Warm" function been used in the following ways? Using for a too long time. Using for anything other than white rice. Using for cold rice. Using when a scoop is still put in the pot. Using for 12 hours or longer. ● Is the cooker body/inner lid/steam port dirty? Please particularly remove the inner lid/the steam port to wash and use a clean cloth to wipe off water droplets every time after cooking. (page 19) ● Has the rice been washed enough? Is the pre-programmed cooking time is too long? (page 11) ● Is the rice left in the pot, with the "Keep Warm" mode off? [Pressing the key by mistake, or disconnecting because of a power failure] ● Did you leave the rice in the inner pot after turning off the "Keep Warm" operation? 	
	Turning a different color Dry	<ul style="list-style-type: none"> ● Are there any foreign substances stuck to the inner lid packing, the brim of inner pot, or the frame of cooker body? ● Are there any foreign substances stuck to the temperature sensor or the outside of inner pot? ● Is the steam port attached properly? ● Is "Keep Warm" time too long? Has the rice been repeatedly reheated? ● "Keep Warm" operation with a small amount of rice may cause the rice at the bottom to get hard and dry, so please gather and pile the rice at the central part of inner pot. 	

(continued)

In Case of Problems (continued)

Trouble Cases		Causes/Points of investigation	(Reference Page)
	Mushy, Sticky	<ul style="list-style-type: none"> ● Please cook rice with less water, then keep it warm. ● After the rice has cooked, loosen it immediately and entirely. ● Gather rice at the central part of the inner pot and sometimes mix together entirely, to prevent it from being left at the inner surface of inner pot. 	
	Tepid	<ul style="list-style-type: none"> ● Please "reheat" before serving. (page 12) ● Is the cooker plug falling of the socket? 	
Rice Cooking	Keeping warm	Steam leakage ※Check after the rice has cooked	<ul style="list-style-type: none"> ● Are there any foreign substances stuck to the inner lid packing, inner pot brim, or on the cooker frame? (page 5) ● Are there any scratches at the inner lid packing? Are there any deformation of the inner lid/inner pot? ● Is the inner lid attached properly? (page 19)
		Boiling over Spattering	<ul style="list-style-type: none"> ● Are there any problems of small amounts of rice, large amounts of water, insufficient rice washing? ● Did you make any mistake of porridge cooking menu? (page 8) ● Are there any foreign substances stuck to the temperature sensor? ● Is it dirty inside the steam port? ● Are the inner lid, the steam port attached properly?
		Thin films appear at the inner pot.	<ul style="list-style-type: none"> ● Oblate-shaped films are sweet constituents (starch) of rice which have melt and dried. There is no abnormality in this case.
		Water droplets appear at the inner lid, inner pot, etc.	<ul style="list-style-type: none"> ● Water droplets may appear at the inner lid, inner pot, etc., in order to prevent drying. There is no abnormality in this case.
		When opening the lid, water drips from the packing, etc.	<ul style="list-style-type: none"> ● When opening the lid, there may be some liquid dripping from the frame, etc., depending on lid opening times, room temperature, etc. ● Are there any foreign substances stuck to the temperature sensor/the outside of inner pot?
		Pre-programmed settings	<ul style="list-style-type: none"> ● Cooking starts immediately ● Rice is not cooked at the pre-programmed time ● Pre-programmed operation cannot be done.
Operation	Indications	It is hard to close the lid. The lid cannot be closed.	<ul style="list-style-type: none"> ● Is the inner lid attached properly? In order to prevent forgetting to attach the inner lid, the outer lid cannot be closed completely without the inner lid attached. (page 19) ● Are there any foreign substances stuck in the gap of hook button, etc.? (page 19)
		Key operation cannot be done.	<ul style="list-style-type: none"> ● Is the plug inserted? Is the inner lid attached? ● Is there any display of "C14", "F01", "F02", etc. on the display panel? (page 23) ● While selecting "Food Preparation" menu, such as (Fermentation), the "pre-programmed" key is not accepted despite pressing it.
		The "Cook" lamp goes off. The operation stops half way.	<ul style="list-style-type: none"> ● If the "OFF" key is pressed by mistake, or if a power failure lasts for a long period, the power will be cut off.
		The remaining cooking time that is indicated does not correspond with the actual cooking time.	<ul style="list-style-type: none"> ● It is possible that the remaining cooking time that is indicated may not correspond with the actual cooking time. It is not because the cooker is out of order. Please see page 9 "Indication of cooking times"
		The indicator of spent time in "Keep Warm" mode blinks.	<ul style="list-style-type: none"> ● It indicates that the rice has been kept warm for a long period of time, so please stop it. (page 12)
		c○○, or F○○ is displayed	<ul style="list-style-type: none"> ● Please see page 23 "Error Indication".

(continued)

In Case of Problems (continued)

Trouble Cases	Causes/Points of investigation	(Reference Page)
Food Preparing	It takes a long time to prepare food. The setup time does not decrease.	<ul style="list-style-type: none"> ● The setup time starts from the "ready-to-cook" temperature. However, it needs some time for heating until the temperature gets ready for cooking. Therefore, actual cooking times will be longer than setup times.
	The food is not well made.	<ul style="list-style-type: none"> ● Finished condition of cooked food may vary depending on ingredients and measuring methods, etc. Please check and confirm the cooking procedures and cooking times. ● The following factors may lead to cooking failure, steam leakage, or cause the lid not to close properly. (page 21) Foreign substances stick to the temperature sensor. The inner pot is deformed. Cooked food is left in the pot. There was a power failure. The cooker connection plug was not inserted to the socket. (page 22)
Others	There is plastic smell.	<ul style="list-style-type: none"> ● At the beginning of use, there may be some unpleasant smell, but it will disappear little by little after using → if feeling worried, please clean it by boiling. (page 19)
	There are scratches, dirt on the outer surface of inner pot.	<ul style="list-style-type: none"> ● After using, coated outer surface may get scratched or get dirty, but there will be no effect on cooking or warming quality.
	The circuit breaker is off, when cooking food.	<ul style="list-style-type: none"> ● If using the cooker with other electric appliances in the same time, power consumption may be overrated, causing the circuit breaker to cut off power. Please use an isolated outlet.

In case of a power failure

Please do in the same way as when the cooker is halfway unplugged, when the cooker connection plug falls out, or when the breaker cuts off power.

During pre-programmed cooking	<ul style="list-style-type: none"> ● After restoring from a power failure, the rice is cooked at the pre-programmed time. If the pre-programmed cooking-start time has already passed, the cooker will start cooking immediately.
During rice cooking	<ul style="list-style-type: none"> ● After restoring from a power failure, immediately the cooker starts cooking.
During keeping warm/ During steam boiling	<ul style="list-style-type: none"> ● After restoring from a power failure, the cooker operation will be in "Keep Warm" mode.



※If the power failure lasts for a long time, the rice may be not well cooked.

Lithium Batteries

The lithium battery installed inside the cooker will last for 4-5 years at the room temperature with the power plug connected. With the lithium battery, the current time can still display and the set time is still stored in the memory even though the power plug is disconnected. If the display lights off or 0:00 flashes on the display, it means that the battery expired. Even if the current time and the set time disappear, the cooker can cook rice as usual. (Pressing CANCEL button will stop the flashing of 0:00.)
Never drop the lithium battery into water or charge, disassemble or heat it.

Error Indication

Please press the "OFF" key, pull the power plug out of the power outlet, and take the following actions.

ERROR INDICATION	Investigation/Action	Restarting
	<ul style="list-style-type: none"> ● Is it a 220V power supply outlet? → Please insert the power plug into a 220V supply outlet. 	<p>After taking action, insert the power plug.</p> <p>Press .</p> <p>[Error indication will disappear.]</p> <p>Wait until the inner pot, inner lid, inner side of the cooker have cooled down. Then, restart.</p>
	<ul style="list-style-type: none"> ● This indicates that the temperature sensor, printed circuit board, etc. are out of order. → Please contact the Toshiba service center for repair. 	

Specifications

Series		RC-10NAF, RC-10NAFE	RC-18NAF, RC-18NAFE	RC-10NAFIH	RC-18NAFIH	RC-10NAFIM	RC-18NAFIM
Power supply		220 V ~ 50 Hz		220 V ~ 50-60 Hz		240 V ~ 50-60 Hz	
Power consumption (cook)		600 W	800 W	600 W	800 W	600 W	800 W
Body dimension	Width	25.3 cm	28.1 cm	25.3 cm	28.1 cm	25.3 cm	28.1 cm
	Depth	33.8 cm	36.5 cm	33.8 cm	36.5 cm	33.8 cm	36.5 cm
	Height	21.1 cm	24.5 cm	21.1 cm	24.5 cm	21.1 cm	24.5 cm
Body weight		3.5 kg	4.4 kg	3.5 kg	4.4 kg	3.5 kg	4.4 kg

Part names and Functions

(Model RC-10NAFI, RC-18NAFI)

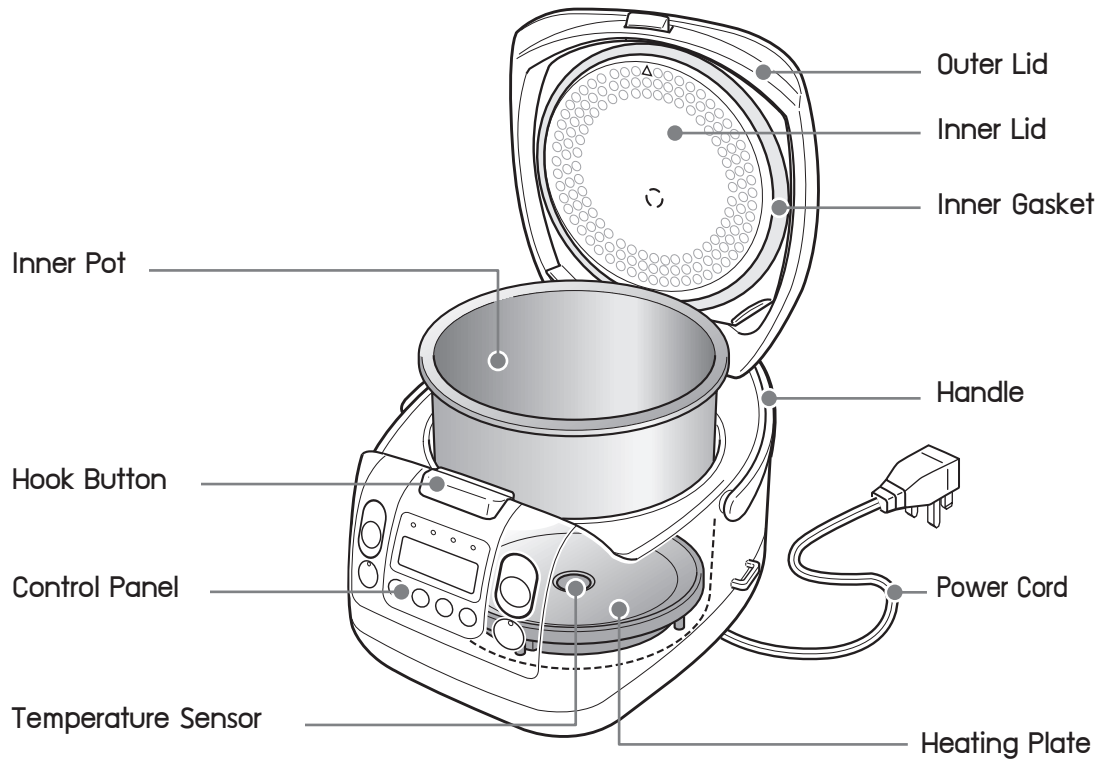

Regarding the Power cord.
For the figure, the Power cord is 3 pins plug for grounded socket version.

If the supply cord is damaged, it must be replaced by a special cord or assembly available from the manufacturer or its service agent.