

# 使用說明書

## 微波爐

MM2-EM20PC(WH)

操作前請仔細閱讀本說明書。

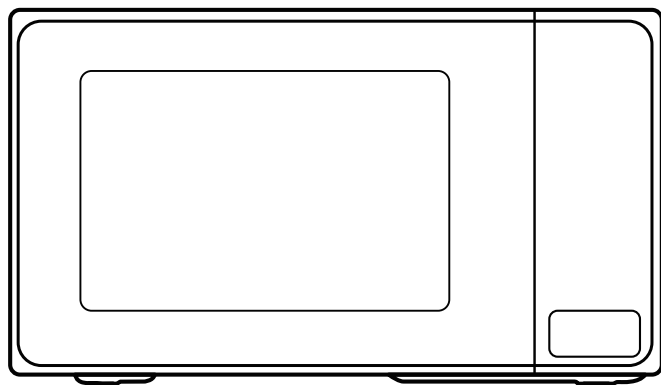

**TOSHIBA**



# 目錄

## 產品安全

避免接觸過量微波能量的預防措施.....	HK-01
重要安全說明.....	HK-03
降低對接地裝置人員造成傷害的風險.....	HK-07
器皿.....	HK-10
可用於微波爐的材料.....	HK-11
不可用於微波爐的材料.....	HK-13

## 產品設置

微波爐安裝.....	HK-14
------------	-------

## 使用說明

首次使用前.....	HK-17
操作.....	HK-18
1. 待機模式.....	HK-19
2. 節能功能.....	HK-19
3. 兒童鎖功能.....	HK-19
4. 微波烹飪.....	HK-19
5. 快速烹飪.....	HK-21
6. 按重量解凍.....	HK-21
7. 多階段烹飪.....	HK-21
8. 熱牛奶.....	HK-23
9. 自動食譜.....	HK-23

## 清潔和維護

清潔.....	HK-25
故障排除.....	HK-27



在操作本產品之前，請閱讀、理解並遵守本說明書。  
請務必保存好本手冊，以備日後參考。

## 避免接觸過量微波能量的預防措施

---

- (a) 不要試圖在門打開的情況下操作本微波爐，因為這可能會接觸到微波能量而造成傷害。不得破壞或者更改安全聯鎖裝置。
- (b) 禁止在微波爐正面和門之間放置任何物體，或在密封面上堆積土壤或清潔劑殘留物。
- (c) **警告：**如果微波爐的門或門密封條有損，須待專業技術人員修好後，方可使用微波爐。

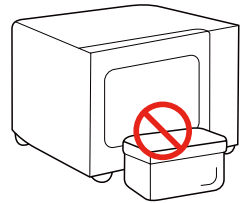

### 後附

---

如設備沒有保持在良好的清潔狀態下，其表面可能會退化、影響設備使用壽命，並造成危險。

## 規格

---

型號	MM2-EM20PC(WH)
額定電壓	220V ~ 50Hz
額定輸入 (微波)	1270W
額定輸出 (微波)	800W
產品尺寸 (闊 x 深 x 高)	440*325*258mm
爐腔尺寸 (闊 x 深 x 高)	306*304*206mm
轉盤直徑	255mm



本手冊中的所有圖片僅用於說明用；這些可能與購買的設備略有不同，請以實際產品為準。

# 重要安全說明



## 警告

為減低使用本電器時發生火災、觸電、人身傷害或接觸於過量微波能量的風險，請遵循以下基本預防措施：



閱讀並遵循以下具體內容：“**「避免接觸過量微波能量的預防措施」**”。

---



本電器不適合身體感到不適、精神狀態不佳智力不佳或缺乏經驗和知識的人員（包括兒童）使用，除非有負責其安全的人員對其使用進行監督或指導。

---



請看管好兒童，切勿讓兒童玩耍本電器。

---



如果電源線損壞，必須由製造商、其服務代理或具有關資格的專業人員進行更換，以避免發生危險。

---



**警告：**更換燈泡之前，請確保已關閉產品電源，以免觸電。

# 重要安全說明

 **警告：**必須由合資格人員執行與拆卸微波能量蓋（此蓋可防止人員接觸微波能量）相關的任何服務或維修操作，否則會造成危險。

---

 **警告：**不得將液體和其他食物置於密封容器中加熱，否則可能會造成爆炸。

---

 使用塑料或紙質容器加熱食物時，請注意觀察微波爐，以防着火。

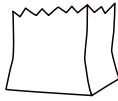

 只能使用適用於微波爐的器皿。

---

 如果冒煙，請關閉本電器或拔下插頭，並保持門關閉，以撲滅火焰。

---

 微波加熱飲品時會導致延遲沸騰，因此取出時必須小心謹慎。

---

 為避免燙傷，在飲用前，應攪拌或搖動奶瓶和嬰兒食物罐的內容物，並檢查溫度。

---

 未能保持微波爐清潔可能導致表面退化，從而可能影響本電器的壽命，並造成危險。



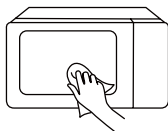

# 重要安全說明

 應對微波爐定期清潔，清理殘存的食物殘渣。請保持微波引導區域清潔。當微波引導區域或爐腔內有食物飛濺殘留物時，用軟濕布清理乾淨。如不清理食物殘留物，微波爐腔內可能會產生無害的火花或煙霧，還可能使爐腔變色。



 僅使用針對本微波爐推薦的溫度探頭。（適用於配有溫度傳感探頭設施的微波爐。）

 必須在裝飾門打開的情況下操作微波爐。（適用於帶裝飾門的微波爐。）

 本設備用於家用和下列類似用途：

1. 店舖內的員工廚房區域、辦公室及其他工作環境；
2. 酒店、汽車旅館和其他居住場所中的客戶；
3. 農舍；
4. 民宿類型環境。

 微波爐用於加熱食物和飲料。烘乾食物或者衣服以及加熱電熱墊、拖鞋、海綿、濕布等可能會造成受傷、着火或者火災的風險。

# 重要安全說明

 本電器為獨立式設備。

 本電器的背面應靠牆放置。

 不得將帶殼的雞蛋和全熟雞蛋放在微波爐中加熱，因為即使在微波加熱結束後，它們也可能爆炸。

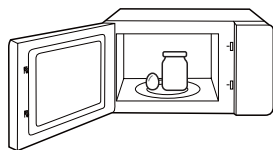

 為避免過熱，禁止將本電器安裝在裝飾門後。

（該要求不適用於帶裝飾門的電器。）

 除非已在櫥櫃對微波爐進行測試，否則請勿將微波爐放入櫥櫃。

 微波烹飪時，不得使用金屬容器盛裝食物和飲料。

 不得使用蒸氣清潔器清潔本電器。

請仔細閱讀並妥善保存以備日後參考

# 降低對接地裝置人員造成傷害的風險

本電器必須接地。若發生電氣短路，接地可以為電流提供逃逸線，從而減少觸電風險。

本電器配有一根電線，該電線帶有接地線和接地插頭。插頭必須插入正確安裝和接地的插座。

**警告** - 接地使用不當會導致觸電風險。如果您不完全理解接地說明或對電器接地的正確性存疑，請諮詢有執業資格的電工或維修人員。

如果需要使用延長線，僅使用三芯延長線。



**危險**

觸電危險：

觸摸某些內部部件會導致嚴重的人身傷害或死亡。  
請勿拆卸本電器。

# 降低對接地裝置人員造成傷害的風險



觸電危險：

接地不當會導致觸電。在電器正確安裝和接地前，請勿插入插座。

1. 提供短電源線，以減少被長電源線纏住或絆倒的風險。
2. 如果使用長線或延長線：
  - (1) 線組或延長線的標記電氣額定值應至少與本電器的電氣額定值相等。
  - (2) 延長線必須是接地型三芯線。
  - (3) 長線的佈置應確保其不會懸垂在台面或桌面上，從而被兒童拉住或無意中絆倒他人。

# 清潔

請確保把本設備的插頭從電源上拔下。

1. 使用後，用微濕的布清潔微波爐腔體。
2. 按常規方法用肥皂水清洗配件。
3. 門框、密封條和相鄰部件髒污時，必須用濕布仔細清潔。
4. 切勿使用粗糙的擦洗劑或鋒利的金屬刮刀來清潔微波爐門玻璃，因為它們會劃傷表面，從而可能導致玻璃破碎。
5. 清潔小貼士 --- 為了更容易地清潔烹飪食物可以接觸到的爐腔壁：將半個檸檬放入碗中，加入 300 毫升（1/2 品脫）水，在 100% 微波功率下加熱 10 分鐘。再用柔軟的乾布將微波爐擦拭乾淨。

# 器皿



**注意**

人身傷害危險：

必須由合資格人員執行與拆卸微波能量蓋（此蓋可防止接觸微波能量）相關的任何服務或維修操作，否則會造成危險。參考“**可用於微波爐的材料**”或“**不可用於微波爐的材料**”。

部分非金屬器皿用微波爐加熱可能不安全。如有疑問，請按照以下程序測試不確定的器皿。

## 器皿測試：

1. 在適用於微波安全容器中加入 1 杯冷水（250ml），將該容器和待測試器皿一起放入微波爐。
2. 在最大功率下烹飪 1 分鐘。
3. 仔細觸摸器皿。如果器皿在空置時有熱度，請勿用於微波烹飪。
4. 烹飪時間不得超過 1 分鐘。

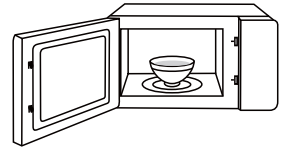

**注意**



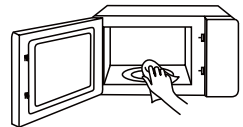





保持微波爐爐腔和波導區域清潔



# 可用於微波爐的材料

餐具	備註	
 燒烤盤	遵循製造商的說明。 燒烤盤的底部必須在轉盤上方至少 3/16 英寸 (5mm)。 使用不當可能造成轉盤損壞。	
 器皿	微波專用。遵循製造商的說明。請勿使用有裂紋或者缺口的盤子。	
 玻璃罐	務必取下蓋子。僅用於加熱食物，直至食物剛好變熱。 大多數玻璃罐不耐熱，可能會破裂。	
 玻璃器皿	僅限耐熱微波爐玻璃器皿。確保沒有金屬裝飾。請勿使用有裂紋或者缺口的盤子。	
 微波爐烹飪袋	請遵循製造商使用說明。請勿用金屬紮帶封閉。 留出縫隙，以便蒸氣逸出。	
 紙盤和紙杯	僅用於短時間烹飪 / 加熱。烹飪時，微波爐必須有人看管。	
 紙巾	用於覆蓋食物以重新加熱和吸收脂肪。僅在監督下用於短時間烹飪。	
 烤盤紙	用作蓋子防止飛濺，或用作包裝防止蒸氣溢出。	

# 可用於微波爐的材料

餐具	備註
 <p data-bbox="164 411 216 435">塑料</p>	<p data-bbox="333 272 900 475">微波專用。遵循製造商的說明。應有貼上“微波安全”的標籤。當裏面的食物變熱時，一些塑料容器會軟化。應按照包裝上的說明，對“可煮袋”和密封塑料袋進行開口、穿孔或通風處理。</p> 
 <p data-bbox="153 627 227 651">保鮮膜</p>	<p data-bbox="333 539 885 624">微波專用。用於烹飪時覆蓋食物，以保持水分。請勿讓保鮮膜接觸食物。</p> 
 <p data-bbox="153 799 227 823">溫度計</p>	<p data-bbox="333 735 758 759">僅限微波爐專用（肉類和糖類溫度計）。</p> 
 <p data-bbox="164 967 216 991">蠟紙</p>	<p data-bbox="333 906 658 930">用作蓋子防止飛濺並保持水分。</p> 



# 不可用於微波爐的材料

餐具	備註	
 鋁盤	可能引起擊穿。應將食物轉移到微波爐安全盤中。	⊗
 帶金屬把手的食物紙箱	可能引起擊穿。應將食物轉移到微波爐安全盤中。	⊗
 金屬或金屬裝飾器皿	金屬阻隔微波能量。金屬裝飾能引起擊穿。	⊗
 金屬扎帶	能引起擊穿，並可導致微波爐着火。	⊗
 紙袋	可能引起微波爐起火。	⊗
 發泡膠	發泡膠在高溫下會融化或污染容器內的液體。	⊗
 木製器皿	木製品在微波爐中使用時會變乾，並可能破裂。	⊗

# 產品設置

## 微波爐安裝

(若產品實物與本手冊中圖片有差異，請以實物為準。)

### 微波爐零部件及配件名稱

從紙箱和微波爐腔體中取出微波爐和所有材料。

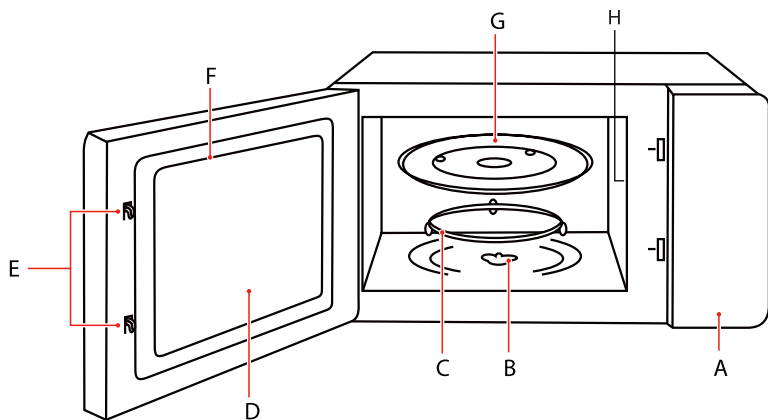
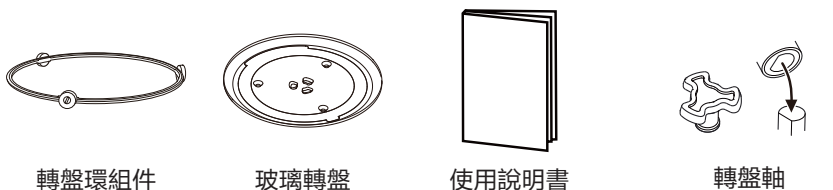

- A. 控制面板
- B. 轉盤軸
- C. 轉盤環組件
- D. 觀察窗口
- E. 安全聯鎖系統
- F. 門組件
- G. 玻璃轉盤
- H. 波導蓋

# 微波爐安裝

## 轉盤安裝

清潔烹飪腔並將轉盤放置就位。

首次安裝時，確保轉盤軸上的所有包裝和運輸用膠帶已清理乾淨。

在首次使用微波爐烹製食品之前，您需要將轉盤正確放置到位並卡好。另外，請務必清潔爐腔以及對應的配件。

按以下步驟操作，將轉盤放置就位：

1. 將轉盤環組件③放置於烹飪腔中凹槽內。
2. 將玻璃轉盤①放在轉盤環組件③上。將玻璃托盤底部中央處凸起的弧形線條嵌入轉盤軸的三個輻條之間。

確保玻璃轉盤①與烹飪腔底面中心位置的轉盤軸②相契合。轉盤軸上的滾輪應安裝在轉盤底部凸緣內。

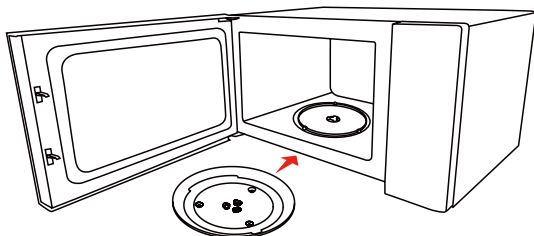
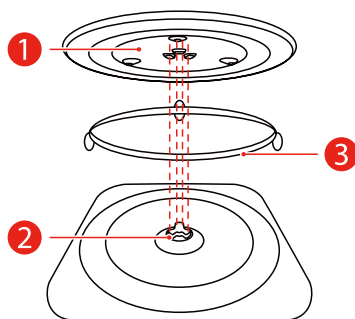

注意

- 切勿在沒有轉盤的情況下使用微波爐。確保正確卡好轉盤。轉盤應能順時針或者逆時針轉動。
- 切勿將玻璃轉盤上下倒置。必須保證玻璃轉盤無障礙順暢運行。
- 烹飪過程中必須使用玻璃轉盤和轉盤環組件。
- 烹飪時，所有食物和食物容器要放在玻璃轉盤上。
- 切勿限制轉盤的轉動。
- 如果玻璃轉盤或轉盤環組件出現裂紋或破裂，請聯絡就近的授權服務中心。

## 枱面安裝

拆除所有包裝材料和配件。檢查微波爐是否有任何損壞，如凹痕或者門破損。如發現微波爐有任何損壞，請勿安裝。

微波爐：去除微波爐表面的保護膜。請勿取下粘在微波爐腔體上保護磁控管的波導蓋。

## 安裝

1. 選擇一個水平面，為進氣口和 / 或排氣口留出足夠的開放空間。
  - a. 最小安裝高度為 85cm。
  - b. 電器的背面應靠牆放置。在微波爐上方至少留出 30cm 的間隙。微波爐和任何相鄰牆壁之間需要至少 20cm 的間隙。
  - c. 請勿取下微波爐底部的支腳。
  - d. 堵塞進氣口和 / 或排氣口會損壞微波爐。
  - e. 將微波爐放置在儘可能遠離收音機和電視的地方。

微波爐運行時可能會干擾收音機或電視接收信號。

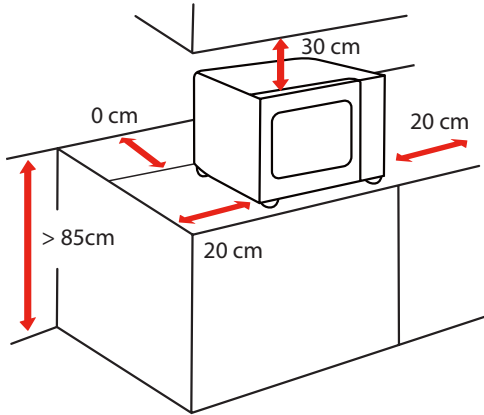

2. 將微波爐插頭插入標準家用插座。確保電壓和頻率與額定值標籤上的電壓和頻率相同。



警告

- 請勿將微波爐安裝在爐灶或其他發熱電器上方。如果安裝在熱源附近或上方，微波爐易損壞，此類情況不在保修範圍內。

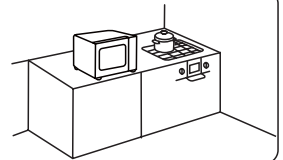

微波爐運行期間，可接觸表面會變熱。

## 首次使用前

**首次使用微波爐時，可能會出現異味，屬於正常現象。**

本節介紹首次使用微波爐準備食物前需要完成的事項。使用前，請先閱讀“**產品安全**”章節。

在使用新微波爐之前，您需要將轉盤正確放置到位並卡好。另外，請務必清潔爐腔以及對應的配件。



**注意**

- 切勿在沒有轉盤的情況下使用本電器。
- 確保各部件正確貼合。轉盤可順時針或逆時針轉動。

# 操作

## 控制面板及功能



## 1. 待機模式

- a 將微波爐插入電源插座後，顯示屏上會出現“0:00”字樣，並且微波爐進入待機模式。
- b 烹製設定完成後，如果在 1 分鐘內未按下“>30s”鍵，則之前的設定無效，並且微波爐會再次進入待機模式。

## 2. 節能功能

通過下列操作進入節能模式：

- a 待機模式下，短按“00⊗”鍵或者若 3 分鐘內無操作，則微波爐顯示屏會熄滅。



通過下列操作取消節能模式：

- b 在節能模式下，按下任意按鍵或者開關微波爐門，都會退出節能模式。

## 3. 兒童鎖功能

您可以使用此功能來防止兒童意外打開微波爐。

啟動兒童鎖：

- a 在待機模式下，長按“00⊗”鍵三秒鐘。  
這時蜂鳴器會響起，並且顯示屏上出現“[ ]”字樣。



取消兒童鎖：

- b 在鎖定狀態下，長按“00⊗”鍵三秒鐘。  
這時蜂鳴器會響起。



## 4. 微波烹飪

有 5 個功率等級。

等級	功率	顯示
1	100%	P100
2	80%	P80
3	50%	P50
4	30%	P30
5	10%	P10

a 按“”鍵一次，顯示“P100”。



b 反覆按下“”鍵或者按下“—”鍵或“+”鍵，以設定火力大小。可以設定 5 級火力大小。



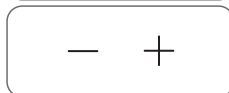

或者



c 按“”鍵確認。



d 按下“—”鍵、“+”鍵、“”鍵，或者按下“”鍵或“”鍵，以設定所需的烹製時長。最長可設定時間為“99:50”。

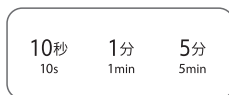

或者

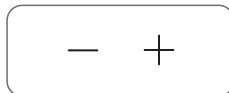

e 按“”鍵開始烹飪。



注

• 在運行過程中，每按一次“”鍵、“”鍵、“”鍵或者“”鍵，就可以相應地增加烹製的時長。



## 5. 快速烹飪

在待機模式下，按下“10秒”<sub>10s</sub> 鍵、“1分”<sub>1min</sub> 鍵和“5分”<sub>5min</sub> 鍵，即可快速選擇烹製時長（100% 火力下）。

如果烹製時長在 5 分鐘以內，則可以直接開始烹製。

否則，必須要按下“▶+30s”鍵才能開始烹製流程。

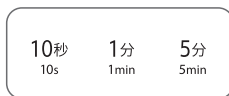

或者



## 6. 按重量解凍

- a 按“(⊗)”鍵一次，顯示“100”。



- b 反覆按下“(⊗)”鍵或者按下“-”鍵或“+”鍵，以設定食品的重量。  
食品重量的設定範圍為 100g 至 2000g。

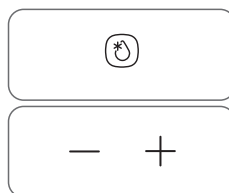

或者

- c 按“▶+30s”鍵開始解凍。



注

• 烹飪過程中，蜂鳴器會響起，提醒您將食物翻面。如果沒有操作，微波爐將繼續工作。

## 7. 多階段烹飪

示例：解凍 500g 食物，然後用 80% 的微波功率烹飪 7 分鐘。

a 按“(🌀)”鍵一次，顯示“100”。



b 反覆按下“(🌀)”鍵或者按下“—”鍵或“+”鍵，以將食品的重量設定為 500g。



或者



c 按“(🌀)”鍵一次，顯示“P100”。



d 反覆按下“(🌀)”鍵或者按下“—”鍵或“+”鍵，以將火力大小設定為 P80。



或者



e 按“(▶+30s)”鍵確認。



f 按下“10秒<sub>10s</sub>”鍵、“1分<sub>1min</sub>”鍵、“5分<sub>5min</sub>”鍵，或者按下“—”鍵或“+”鍵，以將烹製時長設定為 7 分鐘。

10秒<sub>10s</sub> 1分<sub>1min</sub> 5分<sub>5min</sub>

或者



g 按“(▶+30s)”鍵開始烹飪。



注

- 多級烹飪可設置兩個烹飪階段。
- 如果已設置解凍功能，第一階段將自動解凍。
- 任何多階段烹製模式下，不能設定自動食譜和傳感器功能。
- 在運行過程中(除霜模式除外)，每按一次“10秒<sub>10s</sub>”鍵、“1分<sub>1min</sub>”鍵、“5分<sub>5min</sub>”鍵或者“(▶+30s)”鍵，就可以相應地增加烹製的時長。

## 8. 熱牛奶

- a 在待機模式下，短按“”鍵，顯示屏上會出現“250”字樣。



- b 按下“—”鍵或者“+”鍵，以設定食品的重量。



- c 按“”鍵開始烹飪。



### 菜單表

菜單	重量	顯示	功率
	250g (1 杯)	250	
溫奶	500g (2 杯)	500	P100
	750g (3 杯)	750	

## 9. 自動食譜

- a 在待機模式下，短按“”鍵，顯示屏上會出現“01”字樣。



- b 反覆按下“”鍵或者按下“—”鍵或“+”鍵，以選擇需要的菜單。可以選擇 6 個自動菜單。



或者



- c 按“”鍵確認。



- d 按下“—”鍵或者“+”鍵，以設定食品的重量。



- e 按“”鍵開始烹飪。



## 自動菜單表

顯示	菜單	重量	顯示	功率
01	熱粥	250g	250	P100
		500g	500	
02	即食麵	100g	100	P100
		200g	200	
03	爆谷	100g	100	P100
		200g	200	
04	綠葉蔬菜	300g	300	P100
		400g	400	
		500g	500	
		600g	600	
05	蠔油南瓜	200g	200	P100
		300g	300	
		400g	400	
		500g	500	
06	麻婆豆腐	600g	600	P80
		200g	200	
		300g	300	
		400g	400	
		500g	500	
		600g	600	



注意

• 對於菜單“03 爆米花”功能，則請跳過這一步 。

## 清潔

請妥善保養和清潔可以維持電器外表美觀，同時有助於保證電器長時間正常運作。請按照以下說明，妥善安排微波爐保養和清潔。



警告

- 爐門上的玻璃刮痕可能發展成裂縫。  
請勿使用玻璃刮刀、尖銳或磨砂性清潔劑或洗滌劑。
- 如果清潔不當，電器表面可能會損壞。微波能量可能會逸出。  
定期清潔設備，並在使用後立即清理食物殘渣。
- 請勿將電器浸泡在水中或者在水柱下清洗。

## 清潔劑

為確保使用正確的清潔劑，以免損壞不同的表面，請遵循表格中的信息。使用前，徹底清洗新海綿或布。

禁止：



磨砂或磨蝕性清潔劑



金屬或玻璃刮刀清潔門面  
板



金屬或玻璃刮刀清潔門封



硬質擦洗墊或海綿



酒精含量高的清潔劑

## 電器正面

熱肥皂水：

用抹布清潔，然後用軟布擦乾。請勿  
使用金屬或玻璃刮刀進行清潔。

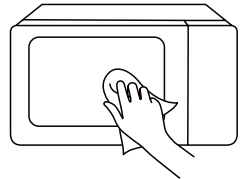

## 不鏽鋼電器正面

### 熱肥皂水：

請使用抹布清潔，然後用軟布擦乾。立即清除水垢、油脂、澱粉和蛋白的飛濺物和斑點。這些斑點或飛濺物會形成腐蝕。請勿使用玻璃清潔劑、金屬，或玻璃刮刀清潔。

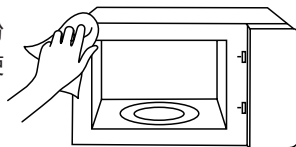

## 不鏽鋼烹飪腔

### 熱肥皂水或醋溶液：

請使用抹布清潔，然後用軟布擦乾。請勿使用微波爐噴霧或任何其他侵蝕性的微波爐清潔劑或研磨材料。百潔布、粗糙的海綿和刷鍋器也不適用。這些物品會劃傷表面。應讓表面完全變乾。

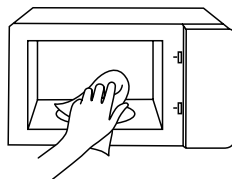

## 烹飪腔凹槽

### 濕布：

切勿讓水通過轉盤傳動裝置流入微波爐內部。用布擦乾轉盤傳動裝置上的水。

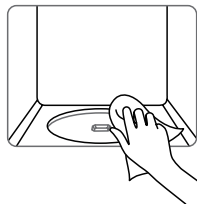

## 轉盤和滾輪圈

### 熱肥皂水：

將轉盤放回凹槽時，必須正確接合。



## 門板

### 玻璃清潔劑：

使用抹布清潔。請勿使用玻璃刮刀。

# 故障排除

根據下圖查看問題，並嘗試每種方法解決問題。  
如果微波爐仍不能正常運作，請聯絡最近的授權服務中心。

故障	可能原因	可能的補救辦法
微波爐無法啟動	a. 微波爐未連接電源。 b. 門未關。 c. 設定錯誤。	a. 插入插座。 b. 關上門，再試一次。 c. 查看說明
有擊穿或火花	a. 器皿不適用於微波爐。 b. 沒有放任何物品在微波爐內。 c. 溢出的食物殘留在腔體。	a. 僅使用微波安全的器皿。 b. 請放入食物。 c. 用濕毛巾清潔腔體。
食物烹飪不均勻	a. 器皿適用於微波爐。 b. 沒有完全解凍食物。 c. 烹飪時長、功率等級不合適。 d. 沒有翻動或攪拌食物。	a. 僅使用微波安全的器皿。 b. 完全解凍食物。 c. 使用正確的烹飪時長、功率等級。 d. 翻動或攪拌食物。
食物過熱	烹飪時長、功率等級不合適。	使用正確的烹飪時長、功率等級。
食物未熟	a. 器皿不適用於微波爐。 b. 沒有完全解凍食物。 c. 微波爐通風口受限。 d. 烹飪時長、功率等級不合適。	a. 僅使用微波安全的器皿。 b. 完全解凍食物。 c. 檢查微波爐通風口不受限。 d. 使用正確的烹飪時長、功率等級。
不能解凍	a. 器皿不適用於微波爐。 b. 烹飪時長、功率等級不合適。 c. 沒有翻動或攪拌食物。	a. 僅使用微波安全的器皿。 b. 使用正確的烹飪時長、功率等級。 c. 翻動或攪拌食物。



根據廢棄電子電機設備指令 (WEEE)，應單獨收集和處理WEEE。日後如需處理本產品，請勿將本產品與生活垃圾一起處理。請將本產品送至WEEE收集點(如有)。

**#DetailsMatter**



# INSTRUCTION MANUAL

# MICROWAVE OVEN

MM2-EM20PC(WH)

Please review this instruction manual before operating.

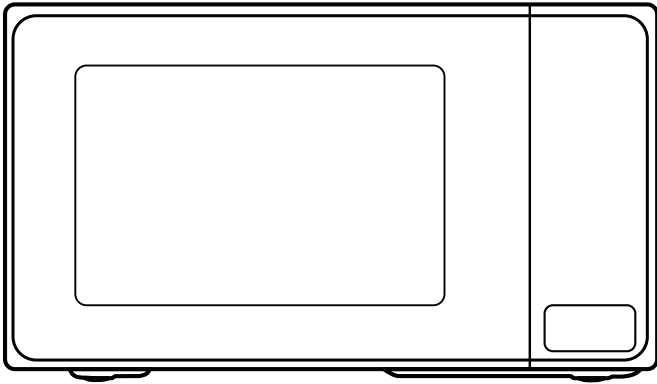

**TOSHIBA**



# CONTENTS

## PRODUCT SAFETY

Precautions to avoid possible exposure to excessive microwave energy .....	EN-01
Specifications .....	EN-02
Important safety instructions .....	EN-03
To reduce the risk of injury to persons grounding installation.....	EN-07
Cleaning .....	EN-09
Utensils.....	EN-10
Materials you can use in microwave oven .....	EN-11
Materials can not be used in microwave oven .....	EN-13

## PRODUCT SETTING

Setting up your oven .....	EN-14
----------------------------	-------

## INSTRUCTION FOR USE

Before using for the first time .....	EN-17
Control panel and features .....	EN-18
1. Standby mode.....	EN-19
2. Eco function.....	EN-19
3. Lock function for children.....	EN-19
4. Microwave cooking .....	EN-20
5. Speedy cooking.....	EN-21
6. Defrost by weight .....	EN-21
7. Multi-stage cooking .....	EN-22
8. Warm milk .....	EN-23
9. Auto menu .....	EN-23

## CLEANING AND MAINTENANCE

Cleaning.....	EN-25
Trouble shooting .....	EN-27



### **NOTE**

BEFORE OPERATING THIS PRODUCT, READ, UNDERSTAND, AND FOLLOW THESE INSTRUCTIONS. BE SURE TO SAVE THIS BOOKLIST FOR FUTURE REFERENCE.

## PRECAUTIONS TO AVOID POSSIBLE EXPOSURE TO EXCESSIVE MICROWAVE ENERGY

---

- (a). Do not attempt to operate this oven with the door open since this can result in harmful exposure to microwave energy. It is important not to break or tamper with the safety interlocks.
- (b). Do not place any object between the oven front face and the door or allow soil or cleaner residue to accumulate on sealing surfaces.
- (c). **WARNING:** If the door or door seals are damaged, the oven must not be operated until it has been repaired by a competent person.

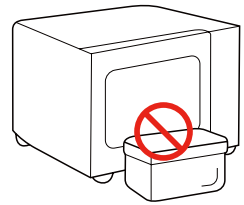

### ADDENDUM

---

If the apparatus is not maintained in a good state of cleanliness, its surface could be degraded and affect the lifespan of the apparatus and lead to a dangerous situation.

## SPECIFICATIONS

---

MODEL	MM2-EM20PC(WH)
RATED VOLTAGE	220 V ~ 50 Hz
MICROWAVE RATED INPUT	1270 W
MICROWAVE RATED OUTPUT	800 W
PRODUCT DIMENSION( WxDxH)	440*325*258mm
CAVITY SIZE(WxDxH)	306*304*206mm
TURNTABLE DIMENSIONS	255mm



### NOTE

All pictures in this manual are for illustrative purposes only; these may be slightly different from the purchased equipment, please refer to the actual product.

# IMPORTANT SAFETY INSTRUCTIONS



## WARNING

To reduce the risk of fire, electric shock, injury to persons or exposure to excessive microwave oven energy when using your appliance, follow basic precautions, including the following:



Read and follow the specific: "**PRECAUTIONS TO AVOID POSSIBLE EXPOSURE TO EXCESSIVE MICROWAVE ENERGY**".



This appliance is not intended for use by persons (including children) with reduced physical, sensory or mental capabilities, or lack of experience and knowledge, unless they have been given supervision or instruction concerning use of the appliance by a person responsible for their safety.



Children should be supervised to ensure that they do not play with the appliance.



If the supply cord is damaged, it must be replaced by the manufacturer, its service agent or similarly qualified persons in order to avoid a hazard.



**WARNING:** Ensure that the appliance is switched off before replacing the lamp to avoid the possibility of electric shock.

# IMPORTANT SAFETY INSTRUCTIONS

 **WARNING:** It is hazardous for anyone other than a competent person to carry out any service or repair operation that involves the removal of a cover which gives protection against exposure to microwave energy.

---

 **WARNING:** Liquids and other foods must not be heated in sealed containers since they are liable to explode.

---

 When heating food in plastic or paper containers, keep an eye on the oven due to the possibility of ignition.



 Only use utensils that are suitable for use in microwave ovens.

 If smoke is emitted, switch off or unplug the appliance and keep the door closed in order to stifle any flames.

---

 Microwave heating of beverages can result in delayed eruptive boiling, therefore care must be taken when handling the container.

---

 The contents of feeding bottles and baby food jars shall be stirred or shaken and the temperature checked before consumption, in order to avoid burns.

---

 Failure to maintain the oven in a clean condition could lead to deterioration of the surface that could adversely affect the life of the appliance and possibly result in a hazardous situation.



# IMPORTANT SAFETY INSTRUCTIONS

-  The oven should be cleaned regularly and any food deposits removed. Please keep the waveguide area clean. Use soft damp cloth to clean it up when there is food splash residue on the waveguide area or the cavity. Failure to clean food residue may cause innocuous sparking or some smoke in the microwave cavity, discoloration of the cavity may also occur.

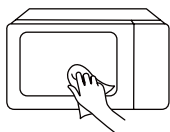

-  Only use the temperature probe recommended for this oven. (for ovens provided with a facility to use a temperature-sensing probe.)

-  The microwave oven must be operated with the decorative door open. (for ovens with a decorative door.)
- 

-  This appliance is intended to be used in household and similar applications such as:
1. staff kitchen areas in shops, offices and other working environments;
  2. by clients in hotels, motels and other residential type environments;
  3. farm houses;
  4. bed and breakfast type environments.
- 

-  The microwave oven is intended for heating food and beverages. Drying of food or clothing and heating of warming pads, slippers, sponges, damp cloth and similar may lead to risk of injury, ignition or fire.

# IMPORTANT SAFETY INSTRUCTIONS

 The appliance is intended to be used freestanding.

---

 The rear surface of appliances shall be placed against a wall.

---

 Eggs in their shell and whole hard-boiled eggs should not be heated in microwave ovens since they may explode, even after microwave heating has ended.

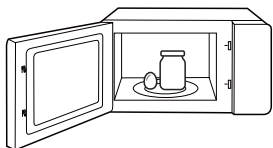

 The appliance must not be installed behind a

decorative door in order to avoid overheating. (This is not applicable for appliances with decorative door.)

---

 The microwave oven shall not be placed in a cabinet unless it has been tested in a cabinet.

---

 Metallic containers for food and beverages are not allowed during microwave cooking.

---

 The appliance shall not be cleaned with a steam cleaner.

READ CAREFULLY AND KEEP FOR  
FUTURE REFERENCE

# TO REDUCE THE RISK OF INJURY TO PERSONS GROUNDING INSTALLATION

This appliance must be grounded. In the event of an electrical short circuit, grounding reduces the risk of electric shock by providing an escape wire for the electric current.

This appliance is equipped with a cord having a grounding wire with a grounding plug. The plug must be plugged into an outlet that is properly installed and grounded.

**WARNING** - Improper use of the grounding can result in a risk of electric shock. Consult a qualified electrician or serviceman if the grounding instructions are not completely understood or if doubt exists as to whether the appliance is properly grounded. If it is necessary to use an extension cord, use only a 3-wire extension cord.



**DANGER**

Electric Shock Hazard:

Touching some of the internal components can cause serious personal injury or death. Do not disassemble this appliance.

# TO REDUCE THE RISK OF INJURY TO PERSONS GROUNDING INSTALLATION



## WARNING

### Electric Shock Hazard:

Improper use of the grounding can result in electric shock. Do not plug into an outlet until appliance is properly installed and grounded.

1. A short power-supply cord is provided to reduce the risks resulting from becoming entangled in or tripping over a longer cord.
2. If a long cord or extension cord is used:
  - (1). The marked electrical rating of the cord set or extension cord should be at least as great as the electrical rating of the appliance.
  - (2). The extension cord must be a grounding-type 3-wire cord.
  - (3). The longer cord should be arranged so that it will not drape over the counter top or tabletop where it can be pulled on by children or tripped over unintentionally.

# CLEANING

Be sure to unplug the appliance from the power supply.

1. Clean the cavity of the oven after using with a slightly damp cloth.
2. Clean the accessories in the usual way in soapy water.
3. The door frame and seal and neighbouring parts must be cleaned carefully with a damp cloth when they are dirty.
4. Do not use harsh abrasive cleaners or sharp metal scrapers to clean the oven door glass since they can scratch the surface, which may result in shattering of the glass.
5. Cleaning Tip---For easier cleaning of the cavity walls that the food cooked can touch: Place half a lemon in a bowl, add 300ml (1/2 pint) water and heat on 100% microwave power for 10 minutes. Wipe the oven clean using a soft, dry cloth.

# UTENSILS



## CAUTION

### Personal Injury Hazard:

It is hazardous for anyone other than a competent person to carry out any service or repair operation that involves the removal of a cover which gives protection against exposure to microwave energy. See the instructions on "**Materials you can use in microwave oven**" or "**Materials can not be used in microwave oven**".

There may be certain non-metallic utensils that are not safe to use for microwaving. If in doubt, you can test the utensil in question following the procedure below.

### Utensil Test:

1. Fill a microwave-safe container with 1 cup of cold water (250ml) along with the utensil in question.
2. Cook on maximum power for 1 min.
3. Carefully feel the utensil. If the empty utensil is warm, do not use it for microwave cooking.
4. Do not exceed 1 min cooking time.

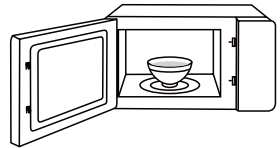





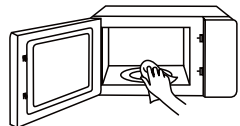











## NOTE









KEEP THE CAVITY AND  
WAVEGUIDE AREA CLEAN



# MATERIALS YOU CAN USE IN MICROWAVE OVEN

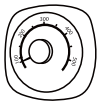









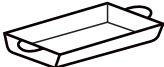



UTENSILS	REMARKS
 <p>Browning dish</p>	<p>Follow manufacturer's instructions. The bottom of browning dish must be at least 3/16 inch (5mm) above the turntable. Incorrect usage may cause the turntable to break.</p> 
 <p>Dinnerware</p>	<p>Microwave-safe only. Follow manufacturer's instructions. Do not use cracked or chipped dishes.</p> 
 <p>Glass jars</p>	<p>Always remove lid. Use only to heat food until just warm. Most glass jars are not heat resistant and may break.</p> 
 <p>Glassware</p>	<p>Heat-resistant oven glassware only. Make sure there is no metallic trim. Do not use cracked or chipped dishes.</p> 
 <p>Oven cooking bags</p>	<p>Follow manufacturer's instructions. Do not close with metal tie. Make slits to allow steam to escape.</p> 
 <p>Paper plates and cups</p>	<p>Use for short-term cooking/warming only. Do not leave oven unattended while cooking.</p> 
 <p>Paper towels</p>	<p>Use to cover food for reheating and absorbing fat. Use with supervision for a short-term cooking only.</p> 
 <p>Parchment paper</p>	<p>Use as a cover to prevent splattering or a wrap for steaming.</p> 

# MATERIALS YOU CAN USE IN MICROWAVE OVEN

UTENSILS	REMARKS
 Plastic	Microwave-safe only. Follow the manufacturer's instructions. Should be labeled "Microwave Safe". Some plastic containers soften, as the food inside gets hot. "Boiling bags" and tightly closed plastic bags should be slit, pierced or vented as directed by package. 
 Plastic wrap	Microwave-safe only. Use to cover food during cooking to retain moisture. Do not allow plastic wrap to touch food. 
 Thermometers	Microwave-safe only (meat and candy thermometers). 
 Wax paper	Use as a cover to prevent splattering and retain moisture. 



# MATERIALS CAN NOT BE USED IN MICROWAVE OVEN

UTENSILS	REMARKS
 <p>Aluminum tray</p>	May cause arcing. Transfer food into microwave-safe dish. 
 <p>Food carton with metal handle</p>	May cause arcing. Transfer food into microwave-safe dish. 
 <p>Metal or metal trimmed utensils</p>	Metal shields the food from microwave energy. Metal trim may cause arcing. 
 <p>Metal twist ties</p>	May cause arcing and could cause a fire in the oven. 
 <p>Paper bags</p>	May cause a fire in the oven. 
 <p>Plastic foam</p>	Plastic foam may melt or contaminate the liquid inside when exposed to high temperature. 
 <p>Wood</p>	Wood will dry out when used in the microwave oven and may split or crack. 

# PRODUCT SETTING

## SETTING UP YOUR OVEN

(In case of any differences between the appliance and the pictures in this manual, the product shall prevail.)

### NAMES OF MICROWAVE OVEN PARTS AND ACCESSORIES

Remove the oven and all materials from the carton and oven cavity.



Turntable Ring Assembly

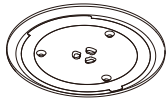

Glass turntable

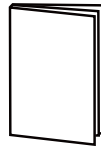

Instruction Manual



Turntable Shaft

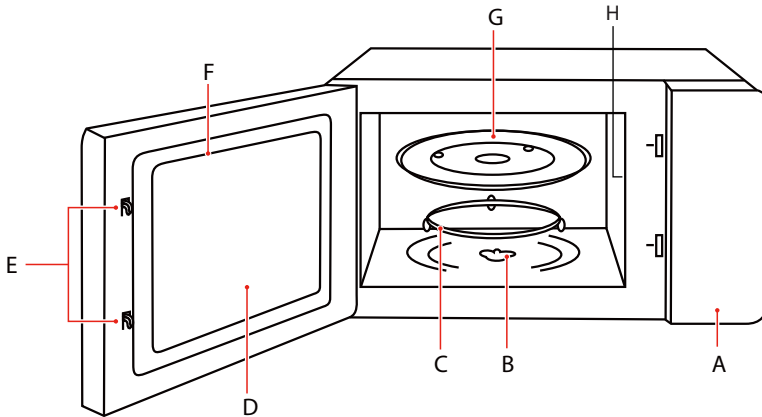

- A. Control panel
- B. Turntable shaft
- C. Turntable ring assembly
- D. Observation window

- E. Safety interlock system
- F. Door assembly
- G. Glass turntable
- H. Waveguide Cover

# SETTING UP YOUR OVEN

## TURNTABLE INSTALLATION

Cleaning the cooking compartment and putting the turntable in place.

For new installations, make sure all packaging and shipping tape has been removed from the turntable shaft.

Before using the appliance to prepare food for the first time, you will need to put the turntable in place correctly. You must clean the cooking compartment and accessories.

How to put the turntable in place:

1. Place the turntable ring assembly ③ into the recess in the cooking compartment.

2. Place the glass turntable ① on the turntable ring assembly ③. Fit the raised, curved lines in the center of the glass turntable bottom between the three spokes of the shaft.

Make sure that the glass turntable ① engages in the turntable shaft ② in the center of the cooking compartment floor. The rollers on the shaft should fit inside the turntable bottom ridge.

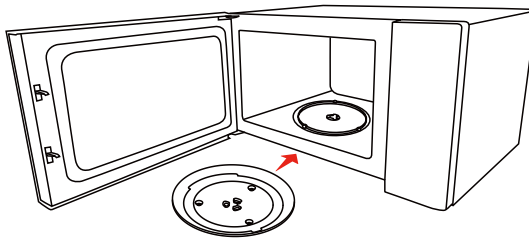
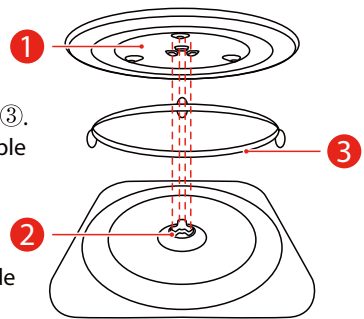

### NOTE

- Never use the appliance without the turntable. Make sure that it is properly engaged. The turntable can turn clockwise or anti-clockwise.
- Never place the glass turntable upside down. The glass turntable should never be restricted.
- Both glass turntable and turntable ring assembly must always be used during cooking.
- All food and containers of food are always placed on the glass turntable for cooking.
- Never restrict the movement of the turntable.
- If glass turntable or turntable ring assembly cracks or breaks, contact your nearest authorized service center.

## COUNTERTOP INSTALLATION

Remove all packing material and accessories. Examine the oven for any damage such as dents or broken door. Do not install if oven is damaged.

Cabinet: Remove any protective film found on the microwave oven cabinet surface. Do not remove the waveguide cover that is attached to the oven cavity to protect the magnetron.

## INSTALLATION

1. Select a level surface that provide enough open space for the intake and/or outlet vents.
  - a. The minimum installation height is 85cm.
  - b. The rear surface of appliance shall be placed against a wall. Leave a minimum clearance of 30cm above the oven. A minimum clearance of 20cm is required between the oven and any adjacent walls.
  - c. Do not remove the legs from the bottom of the oven.
  - d. Blocking the intake and/or outlet openings can damage the oven.
  - e. Place the oven as far away from radios and TV as possible.

Operation of microwave oven may cause interference to your radio or TV reception.

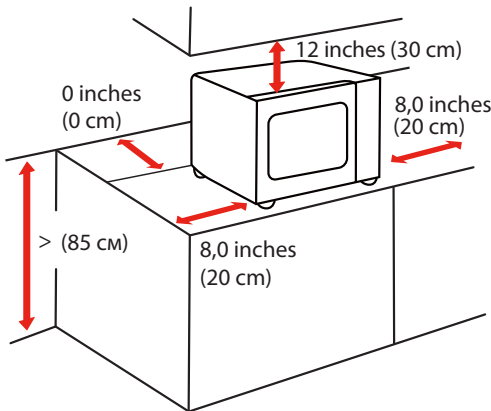

SIDE	DISTANCE (INCHES/CM)
Top	12 inches/30cm
Left	8.0 inches/20cm
Right	8.0 inches/20cm
Behind	0 inches/ 0cm
Front	Open

2. Plug microwave oven into a standard household outlet. Be sure the voltage and the frequency is the same as the voltage and the frequency on the rating label.



**NOTE**

- Do not install oven over a range cooktop or other heat-producing appliance. If installed near or over a heat source, the oven could be damaged and the warranty would be void.

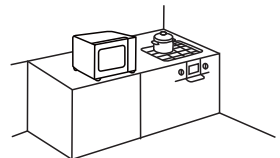

The accessible surface may be hot during operation

# INSTRUCTION FOR USE

## BEFORE USING FOR THE FIRST TIME

**It is normal that the oven may produce unpleasant odors when it is used for the first time.**

This section tells you what you need to do before using your microwave to prepare food for the first time. Read the section entitled "**PRODUCT SAFETY**" beforehand.

Before you can use your new appliance, you will need to put the turntable in place correctly. You must also clean the cooking compartment and accessories.



**NOTE**

- Never use the appliance without the turntable.
- Make sure that it is properly engaged. The turntable can turn clockwise or anti-clockwise.

# OPERATION

## CONTROL PANEL AND FEATURES

---



## 1. STANDBY MODE

---

- a When the microwave oven is plugged into an outlet, "0:00" will display, and the oven will enter the standby mode.
- b After finishing the cooking setting, if  is not pressed within 1 minute, the setting is invalid. And then the oven will enter the standby mode.

## 2. ECO FUNCTION

---



- a To enter ECO mode:  
In standby mode, press  once or if there is no operation within 3 minutes. The screen will turn off.
- b To cancel ECO mode:  
In ECO mode, pressing any key, or opening and closing the door will cancel it.



## 3. LOCK FUNCTION FOR CHILDREN

---

You can use this function to prevent children from accidentally turning the oven on.

- a To activate the lock:  
In standby mode, press and hold  for three seconds. A beep sounds and "" will display.
- b To deactivate the lock:  
In the locked state, press and hold  for three seconds. A beep sounds.



## 4. MICROWAVE COOKING

### 5 power levels are available

LEVEL	POWER	DISPLAY
1	100%	P100
2	80%	P80
3	50%	P50
4	30%	P30
5	10%	P10

a Press  once and then "P100" will display.



b Press  repeatedly or press — or + to set the power level. The 5 power levels are available.

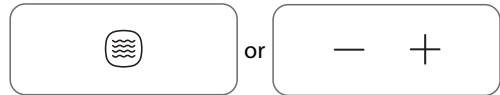

c Press  to confirm.



d Press  $\frac{10\text{秒}}{10\text{s}}$ ,  $\frac{1\text{分}}{1\text{min}}$ ,  $\frac{5\text{分}}{5\text{min}}$ , or press —, or + to set the desired cooking time. The maximum time value is "99:50".

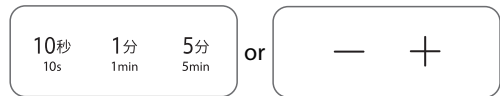

e Press  to start cooking.



#### NOTE

• Each press on " $\frac{10\text{秒}}{10\text{s}}$ ", " $\frac{1\text{分}}{1\text{min}}$ ", " $\frac{5\text{分}}{5\text{min}}$ ", or " " can increase the cooking time by corresponding time during operation.



## 5. SPEEDY COOKING

In standby mode, pressing  $10\text{秒}$ <sub>10s</sub>,  $1\text{分}$ <sub>1min</sub>, and  $5\text{分}$ <sub>5min</sub> lets you quickly select a cooking time with 100% power level. If the cooking time is within 5 minutes, you can directly start cooking. Otherwise, you need to press  $\triangleleft+30S$  to start cooking.

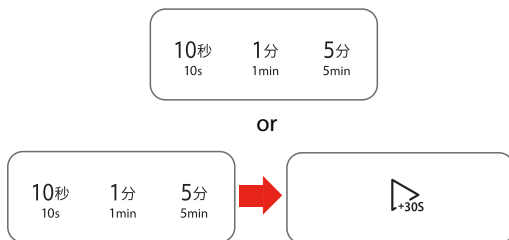

## 6. DEFROST BY WEIGHT

a Press  $\text{⌚}$  once and then "100" will display.



b Press  $\text{⌚}$  repeatedly or press  $-$  or  $+$  to set the weight of the food. The range of weight is 100g to 2000g.

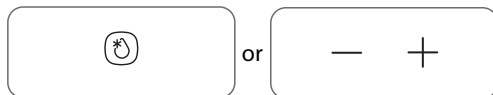

c Press  $\triangleleft+30S$  to start defrosting.





- The buzzer will sound to remind you to turn the food over during defrosting. If no operation, the oven will continue working.

## 7. MULTI-STAGE COOKING

Example: Defrost food for 500g and then cook with 80% microwave power for 7 minutes.

a Press  once and then "100" will display.



b Press  repeatedly or press  or  to set the weight of the food to 500g.





or



c Press  once and then "P100" will display.



d Press  repeatedly or press  or  to set the power level to P80.







or



e Press  to confirm.



f Press   , or press  or  to set the cooking time to 7 minutes.







or



g Press  to start cooking.





**NOTE**

- Two cooking stages can be set in multi-stage cooking.
- If you set the defrost function, it will work automatically in the first stage.
- The auto menu and sensor menu cannot be set as one of the multi-stage.
- Each press on "", "", "", or "" can increase the cooking time by corresponding time during operation (except for defrost).

## 8. WARM MILK

- a In standby mode, press  once, and then "250" displays.



- b Press  or  to set the weight of the food.

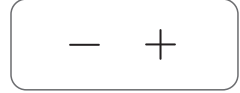

- c Press  to start cooking.







### Menu chart

Menu	Weight	Display	Power
Warm milk	250g (1 cup)	250	P100
	500g (2 cups)	500	
	750g (3 cups)	750	

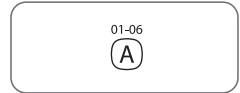
## 9. AUTO MENU

- a In standby mode, press  once and then "01" displays.



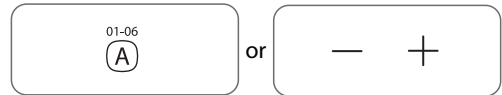

- b Press  repeatedly or press  or  to choose the menu you need. 6 auto menus are available.



- c Press  to confirm.



- d Press  or  to set the weight of the food.

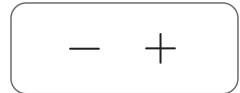

- e Press  to start cooking.



## Auto Menu chart

Display	Menu	Weight	Display	Power
01	Congee	250g	250	P100
		500g	500	
02	Instant Noodles	100g	100	P100
		200g	200	
03	Popcorn	100g	100	P100
		200g	200	
04	Leafy Vegetables	300g	300	P100
		400g	400	
		500g	500	
		600g	600	
05	Stewed Pumpkin in Oyster Sauce	200g	200	P100
		300g	300	
		400g	400	
		500g	500	
06	Mapo Tofu	600g	600	P80
		200g	200	
		300g	300	
		400g	400	
		500g	500	
		600g	600	



### NOTE

- For the menu “03 Popcorn”, please skip the step **d**.

# CLEANING AND MAINTENANCE

## CLEANING

With good care and cleaning, your appliance will retain its appearance and remain fully functioning for a long time to come. Here are the instructions on how to properly care for the microwave oven.



**WARNING**

- Scratched glass in the appliance door may develop into a crack. Do not use a glass scraper, sharp or abrasive cleaning aids or detergents.
- The surface of the appliance may become damaged if it is not cleaned properly. Microwave energy may escape. Clean the appliance on a regular basis, and remove any food remnants immediately.
- Do not immerse the appliance in water or clean under a jet of water.

### Cleaning agent

To ensure that the different surfaces are not damaged by using the wrong cleaning agent, see the information in the table. Wash new sponge or cloth thoroughly before use.

#### Do not use:



Harsh or abrasive cleaning agents



Metal or glass scrapers to clean the door panels



Metal or glass scrapers to clean the door seal



Hard scouring pads or sponges



Cleaning agents with a high alcohol content

### APPLIANCE FRONT

#### Hot soapy water:

Clean using a dish cloth and then dry with a soft cloth. Do not use metal or glass scrapers for cleaning.

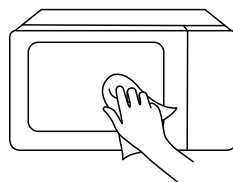

## APPLIANCE FRONT WITH STAINLESS STEEL

---

### Hot soapy water:

Clean using a dish cloth and then dry with a soft cloth. Remove splashes and patches of limescale, grease, starch and albumin immediately. Corrosion can form under these patches or splashes. Do not use glass cleaners or metal or glass scrapers for cleaning.

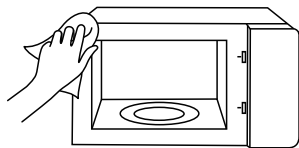

## COOKING COMPARTMENT MADE OF STAINLESS STEEL

---

### Hot soapy water or vinegar solution:

Clean using a dish cloth and then dry with a soft cloth. Do not use oven spray or any other aggressive oven cleaners or abrasive materials. Scouring pads, rough oven sponges and pan cleaners are also unsuitable. These items scratch the surface. Allow the interior surfaces to dry completely.

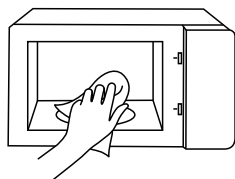

## RECESS IN THE COOKING COMPARTMENT

---

### Damp cloth:

Water must not be allowed to run into the appliance through the turntable drive. Dry the turntable drive with a cloth.

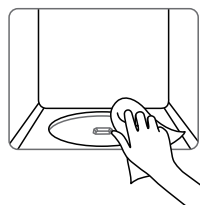

## TURNTABLE AND ROLLER RING

---

### Hot soapy water:

When placing the turntable back into its recess, it must engage properly.



## DOOR PANELS

---

### Glass cleaner:

Clean with a dish cloth. Do not use glass scrapers.

# TROUBLE SHOOTING

Check your problem by using the chart below and try the solutions for each problem.  
If the microwave oven still does not work properly, contact the nearest authorized service center.

TROUBLE	POSSIBLE CAUSE	POSSIBLE REMEDY
Oven will not start	<ul style="list-style-type: none"> <li>a. Electrical cord for oven is not plugged in.</li> <li>b. Door is open.</li> <li>c. Wrong operation is set.</li> </ul>	<ul style="list-style-type: none"> <li>a. Plug into the outlet.</li> <li>b. Close the door and try again.</li> <li>c. Check instructions</li> </ul>
Arcing or sparking	<ul style="list-style-type: none"> <li>a. Materials to be avoided in microwave oven were used.</li> <li>b. The oven is operated when empty.</li> <li>c. Spilled food remains in the cavity.</li> </ul>	<ul style="list-style-type: none"> <li>a. Use microwave-safe cookware only.</li> <li>b. Do not operate with oven empty.</li> <li>c. Clean cavity with soft damp cloth.</li> </ul>
Unevenly cooked foods	<ul style="list-style-type: none"> <li>a. Materials to be avoided in microwave oven were used.</li> <li>b. Food is not defrosted completely.</li> <li>c. Cooking time, power level is not suitable.</li> <li>d. Food is not turned or stirred.</li> </ul>	<ul style="list-style-type: none"> <li>a. Use microwave-safe cookware only.</li> <li>b. Completely defrost food.</li> <li>c. Use correct cooking time, power level.</li> <li>d. Turn or stir food.</li> </ul>
Overcooked foods	<ul style="list-style-type: none"> <li>Cooking time, power level is not suitable.</li> </ul>	<ul style="list-style-type: none"> <li>Use correct cooking time, power level.</li> </ul>
Undercooked foods	<ul style="list-style-type: none"> <li>a. Materials to be avoided in microwave oven were used.</li> <li>b. Food is not defrosted completely.</li> <li>c. Oven ventilation ports are restricted.</li> <li>d. Cooking time, power level is not suitable.</li> </ul>	<ul style="list-style-type: none"> <li>a. Use microwave-safe cookware only.</li> <li>b. Completely defrost food.</li> <li>c. Check to see that oven ventilation ports are not restricted.</li> <li>d. Use correct cooking time, power level</li> </ul>
Improper defrosting	<ul style="list-style-type: none"> <li>a. Materials to be avoided in microwave oven were used.</li> <li>b. Cooking time, power level is not suitable.</li> <li>c. Food is not turned or stirred.</li> </ul>	<ul style="list-style-type: none"> <li>a. Use microwave-safe cookware only.</li> <li>b. Use correct cooking time, power level.</li> <li>c. Turn or stir food.</li> </ul>



According to Waste of Electrical and Electronic Equipment (WEEE) directive, WEEE should be separately collected and treated. If at any time in future you need to dispose of this product please do NOT dispose of this product with household waste. Please send this product to WEEE collecting points where available.

**#DetailsMatter**